



**BELKIN**<sup>®</sup>

# OmniView<sup>®</sup> 2- & 4-Port PS/2 KVM Switch

## User Manual

F1DJ102PeaB  
F1DJ104PeaB





# Table of Contents

<b>1. Introduction</b> .....	<b>1</b>
Package Contents .....	1
<b>2. Overview</b> .....	<b>2</b>
Feature Overview .....	2
Equipment Requirements .....	3
System Requirements .....	4
Unit Display Diagrams .....	5
Specifications.....	6
<b>3. Installation</b> .....	<b>7</b>
Pre-Configuration .....	7
Installation Guide.....	8
Powering Up the Systems.....	10
<b>4. Using your PS/2 KVM Switch</b> .....	<b>11</b>
Selecting a Computer Using the Selector Button .....	11
Selecting a Computer Using Hot-Key Commands .....	11
Selecting a Computer Using the Port-Selector Button .....	12
LED Display.....	12
AutoScan Mode.....	12
Keyboard Hot-Key-Command Shortcut Reference .....	13
<b>5. Frequently Asked Questions</b> .....	<b>14</b>
<b>6. Troubleshooting</b> .....	<b>15</b>
<b>7. Glossary</b> .....	<b>17</b>
<b>8. Information</b> .....	<b>18</b>





## Introduction

Congratulations on your purchase of this Belkin OmniView KVM Switch (the KVM Switch). Our diverse line of KVM solutions exemplifies the Belkin commitment to delivering high-quality, durable products at an affordable price. Designed to give you control over multiple computers from one console, Belkin KVM switches come in a variety of capacities suitable for all configurations, large or small. This compact, affordable KVM switch is backed by a Belkin 3-Year Warranty and free technical support.

This User Manual will provide details about your new PS/2 KVM Switch, from installation and operation to troubleshooting—in the unlikely event of a problem.

Thank you for purchasing the Belkin OmniView PS/2 KVM Switch. We appreciate your business and have confidence that you will soon see for yourself why Belkin is the number-one-selling brand in KVM switches worldwide.

<b>1</b>	<b>section</b>
<b>2</b>	
<b>3</b>	
<b>4</b>	
<b>5</b>	
<b>6</b>	
<b>7</b>	
<b>8</b>	

### Package Contents



**OmniView PS/2 KVM Switch**



**2 KVM Cable Kits (F1DJ102PeaB Only)**



**4 KVM Cable Kits (F1DJ104PeaB Only)**



**User Manual**



**QIG**





## Overview

---

# Feature Overview

- **Hot Keys**

Hot-key functionality allows you to select a desired port using designated key commands. Control up to four computers, depending on the model, using simple hot-key sequences on your keyboard. Full hot-key instructions and commands are listed in this manual, on page 11.

- **AutoScan**

The AutoScan feature allows you to automatically scan and monitor the activities of all connected computers, one by one.

- **Video Resolution**

The PS/2 KVM Switch supports video resolutions of up to 1920x1440 @ 75Hz.

- **Push Button**

A push button, conveniently located on the top panel of the PS/2 KVM Switch, allows for simple, manual port selection.

- **LED Display**

An LED display on the front panel of the PS/2 KVM Switch serves as a status monitor. An LED illuminates to indicate the console that currently controls the corresponding computer.





## Overview

---

# Equipment Requirements

### Cables:

Connecting the PS/2 KVM Switch to a computer requires a Belkin Cable Kit.

Belkin PS/2 Cable Kits:

F1D9000-XX (PS/2-style)

Belkin PS/2 All-in-One Cable Kits:

F3X1105bXX (PS/2-style)

(-XX denotes length in feet)

1  
**2**  
3  
4  
5  
6  
7  
8

section

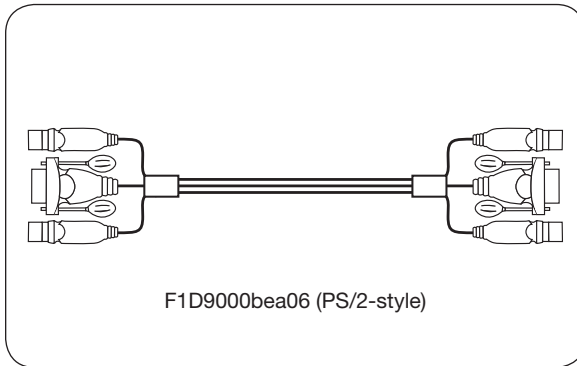



## Overview

---

# System Requirements

## OS Platforms

The PS/2 KVM Switch is compatible with CPUs running on, but not limited to, the following OS platforms:

- Windows® NT®, 2000, XP, Server 2003, or Vista™
- Microsoft® DOS 5.x and above
- Red Hat® Linux® 8.x and above
- Novell® NetWare® 5.x

## Keyboards

- PS/2-compatible
- Supports 101-/102-/104-/106-standard-key keyboards

## Mice

- PS/2-compatible mice (with PS/2 adapter) having 2, 3, 4, or 5 buttons
- PS/2-compatible wireless or optical mice

## Monitors

- CRT
- LCD (with VGA support)

## Optional Power Supply

An optional 9V DC, 600mA power supply is available. This is only required in rare cases where the power output from the connected computer is not adequate to power the KVM Switch.





Overview

# Unit Display Diagrams

## 4-Port PS/2 KVM Switch:

1  
2 section  
3  
4  
5  
6  
7  
8

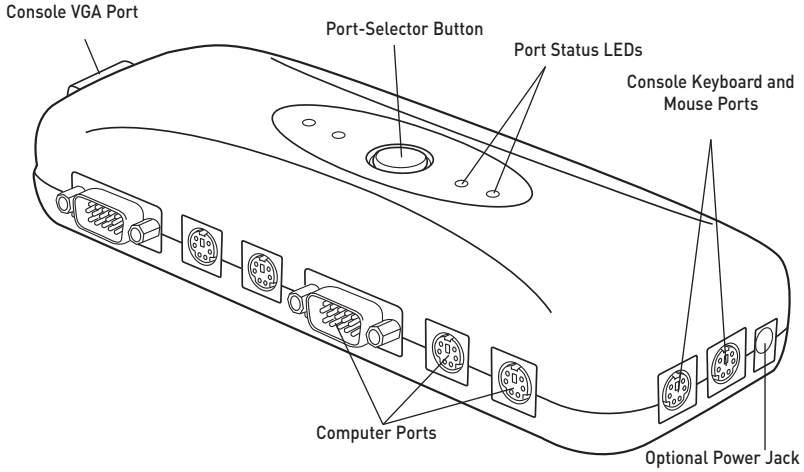



## Overview

---

# Specifications

Part No.:	F1DJ102P, F1DJ104P
Enclosure:	High-impact plastic
Power:	By PS/2 computer ports; optional 9V DC, 600mA power adapter, center-pin-positive polarity
No. of Computers <b>Supported:</b>	2 and 4 respectively for 2- and 4-port models
Monitors Supported:	CRT and LCD (with VGA support)
Max. Resolution:	Up to 1920x1440 @ 75Hz
Keyboard Input:	PS/2 (miniDIN6)
Mouse Input:	PS/2 (miniDIN6)
Monitor Port:	VGA (HDDB15 female)
PC Ports:	HDDB15 male, PS/2 (miniDIN6)
Operating Temp:	32° to 104° F (0~40° C)
Storage Temp:	-4° to 140° F (20~60° C)
Humidity:	0-80% RH, non-condensing
Warranty:	3 years
Dimensions:	(F1DJ102P) 4.5 x 3.5 x 1.25 in. (F1DJ104P) 7.75 x 3.5 x 1.25 in.
Weight:	(F1DJ102P) 7.9oz. (F1DJ104P) 4.8oz.

Note: Specifications are subject to change without notice.







## Pre-Configuration

1

### Where to Place the KVM Switch

2

The OmniView PS/2 KVM Switch is designed to sit on the desktop. Where you place the KVM Switch will be based on the location of your CPUs and the length of your cables.

3

### Consider the following when deciding where to place the KVM Switch:

4

- whether or not you intend to use the port-selector button
- the lengths of the cables attached to your keyboard, monitor, and mouse
- the location of your computers in relation to your console
- the lengths of the cables you use to connect your computers to the KVM Switch

5

### Cable-Distance Requirements:

6

#### For PS/2 Computers:

7

VGA signals transmit best up to 25 feet (7.6m). Beyond that length, the probability of video degradation increases. For this reason, Belkin recommends that the length of the cables between the KVM Switch and the connected computers does not exceed 25 feet (7.6m).

8

### Cautions and Warnings!

Avoid placing cables near fluorescent lights, air-conditioning equipment, or machines that create electrical noise (e.g., vacuum cleaners).



## Installation

---

# Installation Guide

**You are now ready to begin installation of your KVM Switch. The following sections (pages 8–10) provide complete instructions for the hardware setup.**

Before attempting to connect anything to the PS/2 KVM Switch or your computers, ensure that everything is powered off. Plugging and unplugging cables while computers are powered on may cause irreversible damage of the computers and/or the KVM Switch. Belkin is not responsible for damage caused in this way.

## Keyboard, Monitor, and Mouse Connections

### Connecting the Console

#### Step 1

Connect the monitor to the PS/2 KVM Switch. Using the cable that is attached to your monitor, connect it to the HDB15 female port of the PS/2 KVM Switch labeled “VGA Out”. (Refer to diagram below.)

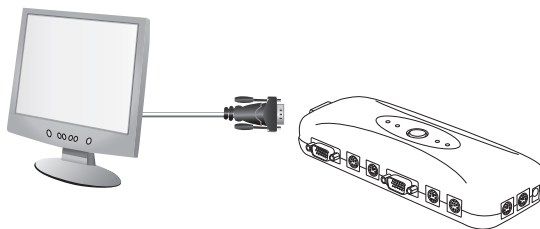

#### Step 2

Connect the PS/2 keyboard to the PURPLE keyboard port on the KVM Switch, located on the same side as the optional power jack. (Refer to diagram below.)

#### Step 3

Connect the PS/2 mouse to the GREEN mouse port on the front of the KVM Switch, located on the same side as the optional power jack. (Refer to diagram below.)

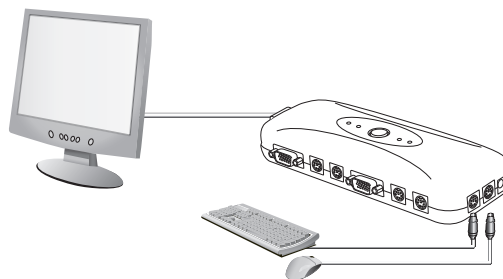

You are ready to connect your computers.





## Installation

### Connecting Computers to the PS/2 KVM Switch:

#### Step 1

Make sure your computer is powered off.

#### Step 2

Using the Belkin PS/2 Cable Kit (F1D9000bea06), take the VGA cable and connect the male end to the VGA port on the first computer. Connect the female end of the cable to the PC1 port located on the long side of the KVM Switch.

(Refer to diagram below.)

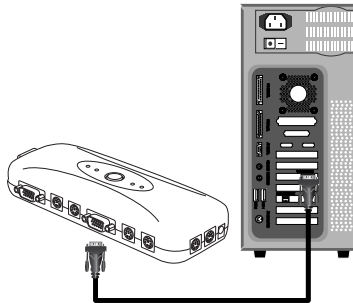

#### Step 3

Connect one end of the PS/2 keyboard KVM cable to the keyboard port on the computer, and the other end to the PURPLE keyboard connector under the PC1 port located on the long side of the KVM Switch. (Refer to diagram below.)

#### Step 4

Connect one end of the PS/2 mouse KVM cable to the mouse port on the computer, and the other end to the GREEN mouse connector under the PC1 port located on the long side of the KVM switch. (Refer to diagram below.)

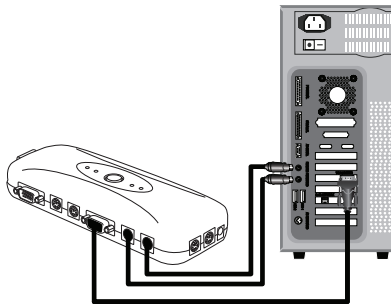

#### Step 5

Power up your computer.

#### Step 6

Repeat Steps 1 through 5 for each additional PS/2 computer you wish to connect.

1

2

3

4

5

6

7

8

section



## Installation

---

### Powering Up the Systems

Verify that all computers connected to the PS/2 KVM Switch are powered on. If any connected computers have not been powered on, it is okay to do so at this time (computers can be powered on simultaneously). The PS/2 KVM Switch emulates both a mouse and keyboard on each port and allows your computer to boot normally. Your PS/2 KVM Switch is ready to use.

The computer connected to port labeled “PC1” will be displayed on the monitor. Check that the keyboard, monitor, and mouse are working normally. Check all occupied ports to verify that all computers are connected and responding correctly. If you encounter an error, check your cable connections for that computer and reboot. If the problem persists, please refer to the “Troubleshooting” section in this User Manual.





## Selecting a Computer Using the Selector Button

You can cycle through the connected computers by pressing the selector button or by using a hot-key command. The LED will be lit next to the port number to indicate which port is currently selected. It takes approximately 1–2 seconds for the video signal to refresh after switching computers. Re-synchronization of the mouse and keyboard signals also occurs. This is normal operation and ensures that proper synchronization is established between the console and the connected computers.

## Selecting a Computer Using Hot-Key Commands

Switch to the next or previous port with simple keyboard hot-key sequences using the “Scroll Lock” key, and either the “Up” or “Down” arrow keys. To send commands to the KVM Switch, the “Scroll Lock” key must be pressed twice within two seconds. The PS/2 KVM Switch will beep, confirming that it is in hot-key mode. Next, press the “Up” arrow key and the PS/2 KVM Switch will switch to the previous port. Press the “Down” arrow key to switch to the next port.

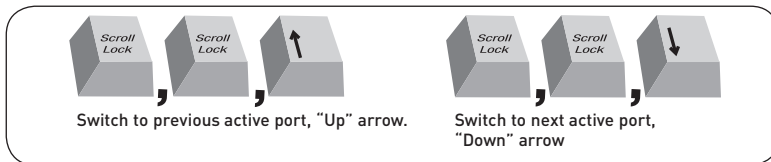

You can switch directly to any port by entering the number of the port you wish to access. For example, if you press “Scroll Lock”, “Scroll Lock”, “2”, the KVM Switch will switch to the computer connected on Port 2.

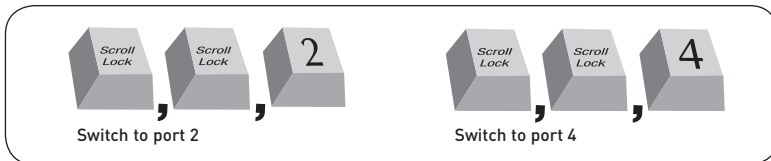

**Note:** You will have approximately four seconds to complete each hot-key sequence.





## Selecting a Computer Using the Port-Selector Button

You can select which computer you wish to control by pressing the port-selector button. The LED will illuminate to indicate the port is currently selected.

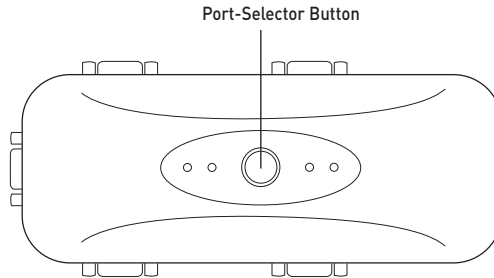

### LED Display

The LEDs on the front panel of the PS/2 KVM Switch serves as a status monitor. An LED illuminates to indicate that the console currently controls the corresponding computer. As a port selector is pushed, the LED will light up as you cycle through the ports. A flashing port LED indicates that there is no computer connected to that port or that the computer connected is powered off. The LED will also blink while the KVM Switch is in AutoScan mode.

**Note:** The port LED will remain solid for some computers that continuously supply power to the keyboard PS/2 port, even while they are shut down.

### AutoScan Mode

In AutoScan mode, the PS/2 KVM Switch remains on one active port for eight seconds before switching to the next active port. This time interval cannot be changed.

To activate the AutoScan function, press “Scroll Lock”, “Scroll Lock”, “S”. You should hear two beeps.

To stop AutoScan, press the port-selector button on the top panel or any key on the keyboard.

**Note:** There is no mouse or keyboard control in AutoScan mode. This is necessary to prevent data and synchronization errors. If the user is using the mouse or keyboard when the PS/2 KVM Switch is switching between ports, data flow may become interrupted and could result in erratic mouse movement and/or wrong-character input when using the keyboard.





## Using your PS/2 KVM Switch

---

### Keyboard Hot-Key-Command Shortcut Reference

Below is a complete list of hot-key commands that can be used for your PS/2 KVM Switch:

**Note:** Each command needs to be preceded by “Scroll Lock”, “Scroll Lock”.

Command	Function
↑	Previous computer
↓	Next computer
[1,2,3,4]	Switch to port “x” (1, 2, 3, 4)
S	Activates AutoScan

**Note:** You will have approximately three seconds to complete each hot-key sequence.

1  
2  
3  
4  
5  
6  
7  
8

section





## Frequently Asked Questions

---

**Q: Which operating systems does the PS/2 KVM Switch support?**

A: The PS/2 KVM Switch will support any operating system that runs on a PS/2 platform only. Operating systems include, but are not limited to, DOS; Windows 2000, NT®, XP, Server 2003, Vista; and Linux.

**Q: Can I connect USB computers on the host side?**

A: No, the PS/2 KVM Switch will support PS/2 computers only.

**Q: How far can the computer be from the KVM Switch?**

A: The KVM Switch can be placed up to 25 feet away from your PS/2 computer.

**Q: What is the maximum video resolution that the PS/2 KVM Switch supports?**

A: The advanced video circuit in the KVM Switch supports a maximum resolution of up to 1920x1440 @ 75Hz.

**Q: Do I have to install any software to use the KVM Switch?**

A: No, the KVM Switch does not require any drivers or software to be installed in your computers. Simply connect all your computers to the Belkin KVM Cable Kits, and then attach one keyboard, monitor, and mouse to the console port, and it is ready for use.

**Q: Does the KVM Switch require an AC adapter?**

A: No, the KVM Switch can be used in the majority of cases without an external power adapter.

**Q: Can I use the KVM Switch to switch video signals only?**

A: No, the KVM Switch must be connected to both the video and keyboard/mouse ports on your computers. The KVM Switch detects the power from the PS/2 ports on your computers in order to function.

**Q: Does the KVM Switch support Linux?**

A: Yes, the KVM Switch works with Red Hat and other Linux distributions configured for PS/2 support.

Q: How long is the warranty for the PS/2 KVM Switch?

A: The KVM Switch comes with a 3-Year Limited Warranty.







## Troubleshooting

---

### **My computer does not boot up when connected to the KVM Switch, but works fine when I connect the keyboard, video, and mouse directly to the computer.**

- Make sure that the keyboard and mouse cables are connected tightly between the KVM Switch and the computer.
- Check that the keyboard and mouse cables are not crossed.
- Check the cable connections.
- Boot the computer with the port selected.

### **I am getting ghosting, shadowing, or fuzzy images on my monitor.**

- Check that all video cables are inserted properly to the Cable Kit.
- Check that the monitor you are using supports the resolution and refresh-rate setting on your computer.
- Lower the video resolution of your monitor.
- Check that the cable length does not exceed 25 feet.
- Check that the graphics card you are using supports the resolution and refresh-rate setting on your computer.
- Connect the monitor directly into the computer with which you are having trouble to see if the problem still appears.

### **I am getting a black screen on my monitor.**

- Check that all video cables are inserted properly.
- Check that the keyboard cable is connected and inserted properly between the computer and the appropriate port on the KVM Switch.
- Move the mouse and see if it is necessary to log in as a user.
- Connect your monitor directly to the computer to verify that your monitor is functioning properly.

### **The computer does not detect a keyboard and I get a keyboard error reported at boot up.**

- Check that the keyboard cable on the KVM Switch is completely connected to your computer. Tighten any loose connections.
- If you are using the keyboard software that was included with your keyboard, uninstall it and then reinstall the standard Microsoft keyboard driver.
- Boot the computer with the port selected.

1

2

3

4

5

6

7

8

section



## Troubleshooting

---

### **The mouse is lost when I switch to a different port.**

- Check that the mouse you are using is connected properly to the console port of the KVM Switch.
- Tighten any loose cable connections.
- If you are using a mouse driver that was included with your mouse, uninstall it and install the standard Microsoft mouse driver.
- Make sure the mouse works when directly plugged into the computer.
- If the computer is coming out of standby mode, allow up to one minute to regain mouse function.
- De-activate power-management schemes on the PC with which you are experiencing problems.
- Try a different mouse.

### **The mouse is not detected at boot up.**

- Check the cables and make sure that they are inserted correctly.

### **The computer boots up, but the mouse does not work.**

- Make sure the mouse is plugged in properly.
- Make sure the mouse works when directly plugged into the computer. Rebooting may be necessary when trying this.
- Try a different mouse.
- Boot the computer with the port selected.

### **When I switch from one port to another, mouse movement is completely erratic.**

- Make sure you do not have more than one mouse driver installed. Make sure that the driver is either for a standard PS/2 or USB mouse, or a PS/2 mouse compatible with Microsoft.
- Make sure you do not have any mouse drivers loaded in your "CONFIG.SYS" or "AUTOEXEC.BAT" files.
- Avoid moving the mouse or pressing the mouse button when switching ports on the KVM Switch.
- Do not switch ports while a computer is booting up.





## Glossary

---

The following definitions are used throughout this User Manual.

**AutoScan:** A mode of operation where the KVM switch scans from one port to another, on an ongoing basis, as configured by the user.

**Console:** The all-in-one term for the keyboard, video monitor, and mouse connected to a KVM switch.

**Console Port:** Receptors for the console to connect to the KVM switch.

**Control:** When discussing switching between ports, control means that the console is capable of sending input to the computer. Control requires that the console also has focus on the port, and is viewing it.

**KVM:** Literally “Keyboard Video Mouse”, this term refers to technology that allows two or more computers to be controlled by one keyboard, video monitor, and mouse; some switches that use KVM technology enable sharing of other peripherals such as audio speakers, microphones, and printers.

**KVM Switch:** A device that allows a user to access and control multiple computers from a single console. It has at least one console port and multiple computer ports.

**Port:** An interface receptor on a computer through which you can attach a device or plug in a device cable.

1

2

3

4

5

6

7

8

section

## FCC Statement

### DECLARATION OF CONFORMITY WITH FCC RULES FOR ELECTROMAGNETIC COMPATIBILITY

We, Belkin International, Inc., of 501 West Walnut Street, Compton CA 90220, declare under our sole responsibility that the products:

#### F1DJ102P, F1DJ104P

to which this declaration relates:

Comply with Part 15 of the FCC Rules. Operation is subject to the following two conditions:

- (1) this device may not cause harmful interference, and
- (2) this device must accept any interference received, including interference that may cause undesired operation.

## CE Declaration of Conformity

We, Belkin International, Inc., declare under our sole responsibility that the products F1DJ102P, F1DJ104P, to which this declaration relates, are in conformity with Emissions Standard EN55022 and with Immunity Standard EN55024, LVP EN61000-3-2, and EN61000-3-3.

## ICES

This Class B digital apparatus complies with Canadian ICES-003. Cet appareil numérique de la classe B est conforme à la norme NMB-003 du Canada.

## Belkin International, Inc., Limited 3-Year Product Warranty What this warranty covers.

Belkin International, Inc. ("Belkin") warrants to the original purchaser of this Belkin product that the product shall be free of defects in design, assembly, material, or workmanship.

### What the period of coverage is.

Belkin warrants the Belkin product for three years.

### What will we do to correct problems?

#### *Product Warranty.*

Belkin will repair or replace, at its option, any defective product free of charge (except for shipping charges for the product).

### What is not covered by this warranty?

All above warranties are null and void if the Belkin product is not provided to Belkin for inspection upon Belkin's request at the sole expense of the purchaser, or if Belkin determines that the Belkin product has been improperly installed, altered in any way, or tampered with. The Belkin Product Warranty does not protect against acts of God such as flood, lightning, earthquake, war, vandalism, theft, normal-use wear and tear, erosion, depletion, obsolescence, abuse, damage due to low voltage disturbances (i.e. brownouts or sags), non-authorized program, or system equipment modification or alteration.



## Information

### How to get service.

To get service for your Belkin product you must take the following steps:

1. Contact Belkin International, Inc., at Express Business Park, Shipton Way, Rushden, NN10 6GL, United Kingdom, Attn: Customer Service, or call (800)-223-5546, within 15 days of the Occurrence. Be prepared to provide the following information:
  - a. The part number of the Belkin product.
  - b. Where you purchased the product.
  - c. When you purchased the product.
  - d. Copy of original receipt.
2. Your Belkin Customer Service Representative will then instruct you on how to forward your receipt and Belkin product and how to proceed with your claim.

Belkin reserves the right to review the damaged Belkin product. All costs of shipping the Belkin product to Belkin for inspection shall be borne solely by the purchaser. If Belkin determines, in its sole discretion, that it is impractical to ship the damaged equipment to Belkin, Belkin may designate, in its sole discretion, an equipment repair facility to inspect and estimate the cost to repair such equipment. The cost, if any, of shipping the equipment to and from such repair facility and of such estimate shall be borne solely by the purchaser. Damaged equipment must remain available for inspection until the claim is finalized. Whenever claims are settled, Belkin reserves the right to be subrogated under any existing insurance policies the purchaser may have.

### How state law relates to the warranty.

THIS WARRANTY CONTAINS THE SOLE WARRANTY OF BELKIN. THERE ARE NO OTHER WARRANTIES, EXPRESSED OR, EXCEPT AS REQUIRED BY LAW, IMPLIED, INCLUDING THE IMPLIED WARRANTY OR CONDITION OF QUALITY, MERCHANTABILITY OR FITNESS FOR A PARTICULAR PURPOSE, AND SUCH IMPLIED WARRANTIES, IF ANY, ARE LIMITED IN DURATION TO THE TERM OF THIS WARRANTY.

Some states do not allow limitations on how long an implied warranty lasts, so the above limitations may not apply to you.

IN NO EVENT SHALL BELKIN BE LIABLE FOR INCIDENTAL, SPECIAL, DIRECT, INDIRECT, CONSEQUENTIAL OR MULTIPLE DAMAGES SUCH AS, BUT NOT LIMITED TO, LOST BUSINESS OR PROFITS ARISING OUT OF THE SALE OR USE OF ANY BELKIN PRODUCT, EVEN IF ADVISED OF THE POSSIBILITY OF SUCH DAMAGES.

This warranty gives you specific legal rights, and you may also have other rights, which may vary from state to state. Some states do not allow the exclusion or limitation of incidental, consequential, or other damages, so the above limitations may not apply to you.

1

2

3

4

5

6

7

8

section



# BELKIN®

## OmniView® 2- & 4-Port PS/2 KVM Switch

# BELKIN®

[www.belkin.com](http://www.belkin.com)

### Belkin Tech Support

UK: 0845 607 77 87

Europe: [www.belkin.com/support](http://www.belkin.com/support)

### Belkin Ltd.

Express Business Park  
Shipton Way, Rushden  
NN10 6GL, United Kingdom  
+44 (0) 1933 35 2000  
+44 (0) 1933 31 2000 fax

### Belkin SAS

130 rue de Silly  
92100 Boulogne-Billancourt  
France  
+33 (0) 1 41 03 14 40  
+33 (0) 1 41 31 01 72 fax

### Belkin B.V.

Boeing Avenue 333  
1119 PH Schiphol-Rijk  
Netherlands  
+31 (0) 20 654 73 00  
+31 (0) 20 654 73 49 fax

### Belkin Iberia

Avda. Cerro del Aguila 3  
28700 San Sebastián de los Reyes  
Spain  
+34 91 625 80 00  
+34 902 02 00 34 fax

### Belkin GmbH

Hanebergstrasse 2  
80637 Munich  
Germany  
+49 (0) 89 14 34 05 0  
+49 (0) 89 14 34 05 100 fax

### Belkin Sweden

Knarramäsgatan 7  
164 40 Kista  
Sweden  
+46 (0) 8 5229 1870  
+46 (0) 8 5229 1874 fax

© 2007 Belkin International, Inc. All rights reserved. All trade names are registered trademarks of respective manufacturers listed. Mac OS, Mac, and Apple are trademarks of Apple Inc., registered in the U.S. and other countries. Windows, Windows Vista, NT, and Microsoft are either registered trademarks or trademarks of Microsoft Corporation in the United States and/or other countries.

P74529ea

