

BELKIN®

NE-L01 LEATHER CASE

Carry your notebook in maximum comfort



ne
NeuElements

Executive Series



The NE-L01 Leather Case by Belkin packs all your electronic essentials and gives you maximum comfort as you travel. It brings together soft leather and attractive fabrics for a unique look, and features an ergonomic strap and soft, sturdy handle for easy lifting. Engineered to deliver the best protection for your notebook, the NE-L01 also provides plenty of storage for pens, pencils, ID cards, papers, CD or MP3 players, and disks. Its tough exterior and sturdy frame ensure you of style that lasts a lifetime.

Manufacturer's
Lifetime
Warranty

 **Smart Storage**



 **Maximum Laptop Protection**

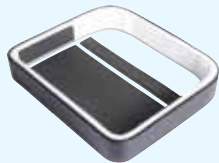

 **Clamshell Style**



 **Elastic Shoulder Strap**



 **File-Folder Pocket**



Carry your notebook in maximum comfort

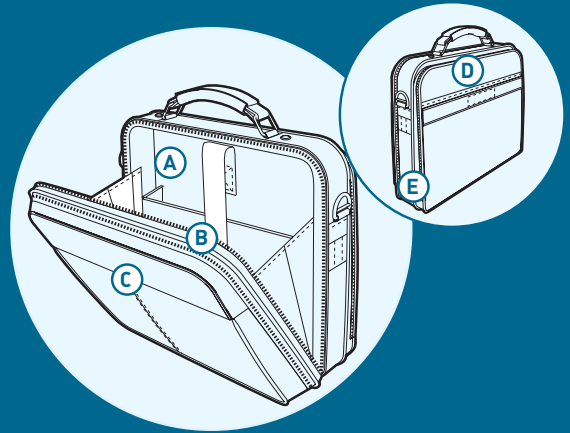

FEATURES & BENEFITS

- A** Durable, honeycomb-frame construction
- B** Detachable business-card holder
- C** Easy quick-access pocket
- D** Genuine leather exterior
- E** Rear-section file compartment



NeuElements RATING SYSTEM

1 2 3 4 5
Good Best

| | | |
|--|----------|---|
|  Durability | 5 | Our frontline NE series accents ballistic nylon with our new Synthesis2 fabric, lending luxury to rugged endurance. Microfiber and Napa blends round out our upscale editions. |
|  Smart Storage | 5 | NE cases provide easy-access storage for your business essentials, perfect for use on the fly—in airports, waiting rooms, limos, and other offices. Removable cases add functionality. |
|  Comfort | 5 | NE architecture emphasizes comfort to ease your travel experience. Featuring straps of soft-elastic neoprene, and ergonomic non-slip leather or nylon handles, the cases manage easily when fully loaded. |
|  Protection | 5 | Our superior construction focuses on meticulous material selection and evaluation. For the best shock-damage protection, we use thick foam padding and an internal, rigid frame. |
|  Lifestyle | 5 | NE products put technology in motion with designs that fit a range of mobile lifestyles. We let form meet function, and guarantee our cases for life. |

ne NeuElements | Check out our entire line of bags

- **Executive Series**
High-functionality and savvy, business-class looks are yours, with our durable designs built of the finest materials.
- **Business Casual Series**
These hardworking models increase your uptime on the road, and promise years of reliable, comfortable transport.
- **Studio Series**
Step up to modern styling with innovative designs that combine flair with rugged durability.

STUFF BAK
www.stuffbak.com

StuffBak provides a seamless loss-protection service that helps retrieve your missing possessions. Your Belkin NE case includes our unique ID that tells the finder how to return it easily and get a reward, too. Placing a StuffBak label on any of your important gear can help you get it back, and avoid desperate Lost & Found searches.



| Part Number | Description | Fits notebooks up to |
|-------------|---------------------|---|
| F8L001ea | NE-L01 Leather Case | 36.8 x 30.5 x 5.1 cm (14.5" x 12.0" x 2.0") |

| | | | | | |
|---|--|--|---|---|---|
| Belkin Corporation 310 898 1100 Compton • CA • USA | Belkin Ltd. +44 (0) 1933 35 2000 Rushden • United Kingdom | Belkin B.V. +31 (0) 20 654 7300 Schiphol-Rijk • The Netherlands | Belkin GmbH +49 (0) 89 143 4050 Munich • Germany | Belkin SAS +33 (0) 1 41 03 14 40 Boulogne-Billancourt • France | Belkin Ltd. +61 (0) 2 4372 8600 West Gosford • Australia |
|---|--|--|---|---|---|

© 2005 Belkin Corporation. All rights reserved. All trade names are registered trademarks of respective manufacturers listed.

BELKIN®

NE-L01 LEDEREN TAS

De meest praktische reistas voor uw laptop



ne
NeuElements

Executive Serie



Met volop ruimte voor uw complete elektronische uitrusting is deze lederen draagtas NE-L01 van Belkin ideaal voor op reis. De combinatie van soepel leder en een stijlvolle binnenbekleding geven deze computertas een unieke uitstraling waarbij de ergonomische draagriem en de zachte stevige handgreep zorgen voor extra draagcomfort. Een betere bescherming van uw laptop dan deze NE-L01 is nauwelijks denkbaar; daarbij is er veel ruimte voor uw pennen, potloden, paspoort en creditcards, een cd- of mp3-speler en cd's. De slijtvaste buitenkant en het stevige frame zorgen voor een tijdloze tas die jarenlang meegaat.

Levenslange
fabrieks-
garantie



Praktische
opberg-
ruimte



Volledige
laptop-
bescherming

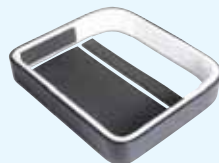

Volledig
open-
klapbaar



Elastische
schouder-
band



Documenten-
vak



EIGENSCHAPPEN EN VOORDELEN

- A** Duurzame constructie met honingraatframe
- B** Afneembare houder voor visitekaartjes
- C** Gemakkelijk toegankelijke buitentas
- D** Buitenzijde van echt leder
- E** Afzonderlijk achtervak voor documenten

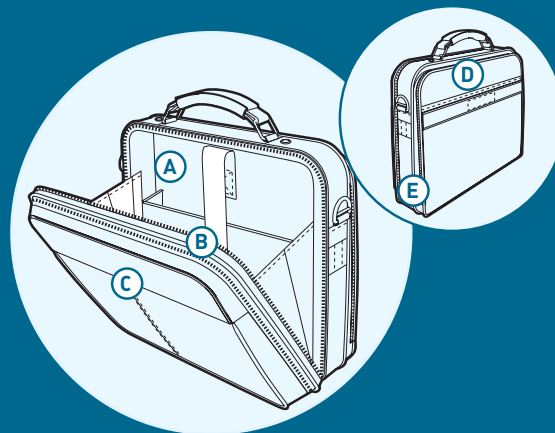

NeuElements WAARDERING

1 2 3 4 5
Goed Uitstekend

| | | | |
|---|---------------------------------|----------|--|
|  | Duurzaamheid | 5 | Onze geavanceerde NE-serie werkt met ballistisch nylon en het nieuwe Synthis2 materiaal dat luxe combineert met grote slijtvastheid. Microfiber en nappa geven de hoger geprijsde modellen een extra cachet. |
|  | Praktische opberg-ruimte | 5 | In een NE-tas zijn al uw bescheiden onder handbereik – ideaal om uw beschikbare tijd op luchthavens, in hotels, taxi's en kantoren optimaal te besteden. Dit type draagtas kunt u indelen zoals u wilt. |
|  | Comfort | 5 | De constructie van het NE model is gebaseerd op praktische bruikbaarheid en daar hebt u onderweg veel plezier van. Met een draagriem van zacht meeverend neopreen en ergonomisch gevormde handgrepen van slipvast leder of nylon zijn deze draagtassen gemakkelijk te vervoeren. |
|  | Bescherming | 5 | Al onze ontwerpen maken gebruik van zorgvuldig gekozen materialen met een lange levensduur. Wij gebruiken een dikke voering van kunststofschuim en een stijf inwendig frame als optimale beveiliging tegen schokken en trillingen. |
|  | Levensstijl | 5 | NE producten combineren de nieuwste materialen en technieken met een vormgeving die perfect aansluit bij een snelle mobiele lifestyle. Het perfecte evenwicht tussen vorm en functie dat wij met overtuiging levenslang garanderen. |

ne NeuElements | U kiest uit een compleet programma

- **Executive Serie**
Deze functionele computertassen van de beste materialen en met een doordacht gebruikskomfort hebben business-class uitstraling.
- **Business Casual Serie**
Met een Belkin computertas werkt u efficiënter en is uw mobiele computeruitrusting op reis jarenlang veilig beschermd.
- **Studio Serie**
In deze geavanceerde draagtas is uw mobiele computeruitrusting overal onderweg mooi en veilig beschermd.

STUFF BAK
www.stuffbak.com

StuffBak is een betrouwbare service die uitkomst biedt bij het terugbezorgen van zoekgeraakte voorwerpen bij de rechtmatige eigenaar. Uw Belkin NE draagtas is voorzien van een unieke identificatiecode waarmee de vinder u de tas eenvoudig en tegen beloning kan terugbezorgen. Een StuffBak label op uw onmisbare bezittingen vergroot de kans op terugbezorging en bespaart u tijdrovende zoektochten bij Gevonden Voorwerpen.



| Artikelnummer | Beschrijving | Geschikt voor laptops en notebooks tot |
|---------------|-------------------------|--|
| F8L001ea | NE-L01 Lederen draagtas | 368 x 305 x 51 mm |

Belkin Corporation
+1 310 898 1100
Compton • CA • USA
Belkin Ltd.
+44 (0) 1933 35 2000
Rushden • Verenigd Koninkrijk

Belkin B.V.
+31 (0) 20 654 7300
Schiphol-Rijk • Nederland
Belkin GmbH
+49 (0) 89 143405 0
München • Duitsland

Belkin SAS
+33 (0) 1 41 03 14 40
Boulogne-Billancourt • Frankrijk
Belkin Ltd.
+61 (0) 2 4372 8600
West Gosford • Australië

©2005 Belkin Corporation. Alle rechten voorbehouden. Alle handelsnamen zijn geregistreerde handelsmerken van de betreffende rechthebbenden.

BELKIN®

SAC EN CUIR NE-L01

La solution de confort maximum pour votre ordinateur portable



ne
NeuElements

Série Executive

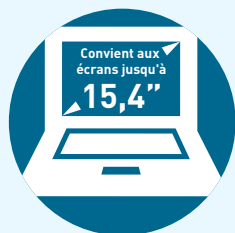

Le Sac en cuir NE-L01 de Belkin vous permet de ranger tous vos accessoires et vous procure un confort maximum sur la route. Ce sac réunit un cuir souple et des tissus attrayants lui donnant un look unique en son genre, et présente une bandoulière ergonomique et une poignée souple mais robuste. Conçu afin d'offrir la meilleure protection pour votre ordinateur portable, le sac NE-L01 vous procure en outre de nombreux espaces de rangement pour vos stylos, crayons, cartes, papiers, CD, lecteurs de MP3 et disquettes. Son revêtement extérieur solide et son cadre robuste vous donne l'assurance d'une protection durable.

Garantie à vie
du fabricant



Rangement
Bien
Pensé



Protection
maximum
pour votre
portable

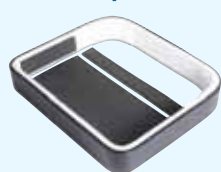

Ouverture
complète



Bandoulière
extensible



Pochette
pour
dossiers et
documents



CARACTÉRISTIQUES ET AVANTAGES

- A** Structure alvéolaire durable
- B** Porte-cartes de visite amovible
- C** Pochette à accès facile
- D** Revêtement extérieur en cuir véritable
- E** Compartiment arrière pour dossiers

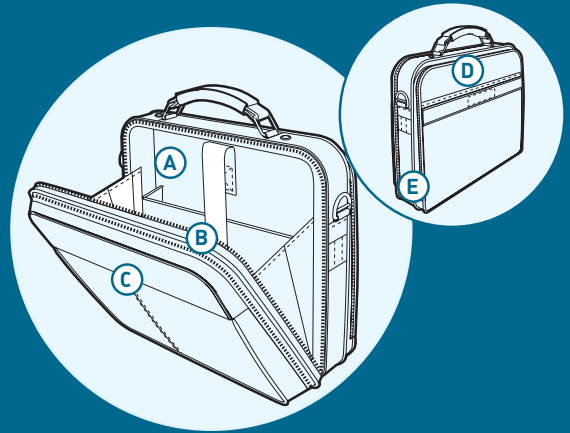

ÉCHELLE DE QUALITÉ NeuElements

1 2 3 4 5
BonMeilleur

| | | | |
|---|-----------------------------|----------|---|
|  | Durabilité | 5 | Notre série de sacs NE allie le nylon balistique à notre nouveau tissu, le SynthiS2, mariant à merveille l'élégance à la robustesse. Sur nos modèles de prestige, vous retrouvez un mélange de microfibres et de cuir Napa. |
|  | Rangement Bien Pensé | 5 | Les sacs NE vous procurent des espaces de rangement pour vos accessoires professionnels, parfaits pour les aéroports, salles d'attentes, les limousines et autres bureaux mobiles. Les étuis amovibles rehaussent son côté pratique. |
|  | Confort | 5 | Le design des sacs NE met l'accent sur un confort maximum lors de vos déplacements. Avec leurs bandoulières en néoprène légèrement extensibles et leurs poignées ergonomiques anti-glisse en cuir ou en nylon, les sacs se transportent aisément - même lorsqu'ils sont pleins à craquer. |
|  | Protection | 5 | Notre fabrication de qualité supérieure prend racine dans l'évaluation et la sélection méticuleuse des matériaux. Pour la meilleure protection anti-chocs, nous utilisons un épais rembourrage en mousse et un cadre interne rigide. |
|  | Mode de Vie | 5 | Les produits NE donnent un élan à la technologie, avec leurs designs répondant parfaitement au mode de vie des professionnels d'aujourd'hui. Le style se marie à la forme, et nous garantissons nos sacs à vie. |

ne Découvrez notre
NeuElements ligne de sacs

- Série Executive**
Pour un look très classe et une fonctionnalité améliorée, procurez-vous nos sacs les plus durables, fabriqués avec des matériaux raffinés.
- Série Business Casual**
Ces modèles durables vous garantissent la plus grande efficacité sur la route, et vous promettent de longues années de fiabilité et de confort.
- Série Studio**
Offrez-vous ces nouveaux designs qui ajoutent une touche d'élégance tout en protégeant votre ordinateur et vos accessoires.



www.stuffbak.com

StuffBak vous procure un service de protection qui vous permet de retrouver vos précieuses possessions. Votre sac NE de Belkin possède un numéro d'identification unique qui indique à la personne qui retrouve votre sac comment le retourner... et même recevoir une récompense. En plaçant l'étiquette StuffBak sur vos possessions peut aider à les retrouver, et vous évitez de longues heures au département des objets trouvés.



| Référence | Description | Convient aux ordinateurs portables jusqu'à |
|-----------|--------------------|--|
| F8L001ea | Sac en cuir NE-L01 | 368 x 305 x 51 mm |

Belkin Corporation
+1 310 898 1100
Compton • CA • États-Unis
Belkin Ltd.
+44 (0) 1933 35 2000
Rushden • Royaume-Uni

Belkin B.V.
+31 (0) 20 654 7300
Schiphol-Rijk • Pays-Bas
Belkin GmbH
+49 (0) 89 143405 0
München • Allemagne

Belkin SAS
+33 (0) 1 41 03 14 40
Boulogne-Billancourt • France
Belkin Ltd.
+61 (0) 2 4372 8600
West Gosford • Australie

© 2005 Belkin Corporation. Tous droits réservés. Toutes les raisons commerciales sont des marques déposées de leurs fabricants respectifs.

BELKIN®

NE-L01 LEDERTASCHE

Maximaler Tragekomfort für Ihr Notebook



ne
NeuElements

Executive-Serie



Die NE-L01 Ledertasche von Belkin hat Platz für alle Ihre elektronischen Reisebegleiter und bietet Ihnen maximalen Reisekomfort. Weiches Leder und moderne Materialien werden attraktiv kombiniert. Ein ergonomischer Trageriemen und ein weicher, aber stabiler Griff machen Ihnen das Tragen leicht. Geschaffen für den bestmöglichen Schutz Ihres Notebooks, bietet die NE-L01 außerdem jede Menge Stauraum für Stifte, Füller, Personalausweis, Dokumente, CD- oder MP3-Player und Datenträger. Das robuste Außenmaterial und der stabile Rahmen sorgen dafür, dass die Tasche ein Leben lang hält.

Lebenslange
Hersteller-
garantie

**Kluge
Einteilung**
Max



**Höchster
Laptop-
Schutz**

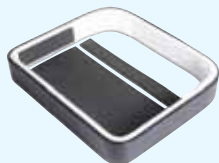

**Koffer-
mechanismus**



**Elastische
Schulter-
riemen**



**Mappen-/
Ordnetasche**



FUNKTIONEN UND VORZÜGE

- A** Stabile Wabenkonstruktion
- B** Abnehmbares Visitenkartenfach
- C** Leicht zugängliche Tasche
- D** Außenmaterial aus echtem Leder
- E** Aktenfach an der Taschenrückseite

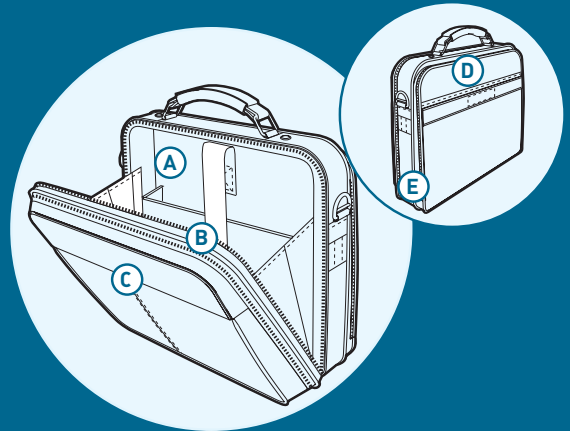

NeuElements -QUALITÄTSSTUFEN 1 2 3 4 5

Standard Exklusiv

| | | | |
|---|-------------------------|----------|--|
|  | Haltbarkeit | 5 | Unsere Spitzenserie NE ergänzt das bewährte Ballistic-Nylon durch unser neues Synthesis2-Material und verleiht der unverwüstlichen Qualität einen Hauch von Luxus. Mikrofaser und echtes Nappa-Leder machen unsere exklusiven Modelle zu edlen Begleitern. |
|  | Kluge Einteilung | 5 | NE-Taschen bieten leicht zugänglichen Stauraum für Ihre BüROUTENSILIEN und sind ideal für Flughäfen, Wartezimmer, Taxi und die Arbeit in anderen Büros. Besonders praktisch durch abnehmbare Funktionstaschen. |
|  | Komfort | 5 | Bei NE-Taschen wird Reisekomfort ganz groß geschrieben. Riemen aus angenehm elastischem Neopren und ergonomische, rutschfeste Griffe aus Leder oder Nylon bieten auch bei voller Tasche einfache Handhabung. |
|  | Schutz | 5 | Zum durchdachten Design gehören sorgfältig ausgewählte Materialien. Zuverlässigen Stoßschutz erzielen wir mit dicker Schaumstoffpolsterung und einem stabilen Innenrahmen. |
|  | Lifestyle | 5 | NE-Produkte setzen Technologie mit variantenreichen Designs in Bewegung. Jedes Design passt genau zu einem mobilen Lebensstil. Wir lassen Form und Funktion zusammenkommen und garantieren lebenslange Qualität. |

ne NeuElements | Unser umfassendes Sortiment bietet auch für Sie die ideale Tasche

- **Executive-Serie**
Praktisch, funktional und attraktiv: Mit dieser Business-Klasse treten Sie stilvoll auf und zeigen, dass feinste Materialien und zuverlässige Verarbeitung Ihrer Natur entsprechen.
- **Business Casual-Serie**
Geschaffen für harte Arbeit. Diese Modelle unterstützen Sie bei Ihren Aufgaben unterwegs und versprechen jahrelangen Reisekomfort.
- **Studio-Serie**
Sprengen Sie die Grenzen mit neuen Formen, die Ihren Werkzeugen unterwegs Schutz und ein stilvolles Äußeres bieten.



www.stuffbak.com

StuffBak ist der Service für den lückenlosen Schutz vor Verlust, der Ihnen hilft, verlorengegangene Gegenstände zurückzubekommen. Ihre Belkin NE-Tasche besitzt eine einmalige Kennnummer, die dem Finder zeigt, wie er sie zurückgeben kann und dafür eine Belohnung erhält. Wenn Sie ein StuffBak-Etikett auf wichtige Utensilien aufkleben, können Sie sie leichter zurückbekommen und vermeiden die verzweifelte Suche im Fundbüro oder durch Kleinanzeige.



| Artikel-Nummer | Beschreibung | Passend für Notebooks bis zu |
|----------------|--------------------|------------------------------|
| F8L001ea | NE-L01 Ledertasche | 368 x 305 x 51 mm |

Belkin Corporation
+1 310 898 1100
Compton • CA • USA
Belkin Ltd.
+44 (0) 1933 35 2000
Rushden • Großbritannien

Belkin B.V.
+31 (0) 20 654 7300
Schiphol-Rijk • Niederlande
Belkin GmbH
+49 (0) 89 143405 0
München • Deutschland

Belkin SAS
+33 (0) 1 41 03 14 40
Boulogne-Billancourt • Frankreich
Belkin Ltd.
+61 (0) 2 4372 8600
West Gosford • Australia

© 2005 Belkin Corporation. Alle Rechte vorbehalten. Alle Produktnamen sind eingetragene Marken der angegebenen Hersteller.

BELKIN®

MALETÍN DE PIEL NE-L01

Lleve su portátil con el máximo confort



ne
NeuElements

Series ejecutivo



El Maletín de piel NE-L01 de Belkin le proporciona espacio para todos sus componentes electrónicos básicos y consigue el máximo confort para sus desplazamientos. Combina una suave piel con atractivos tejidos para obtener un aspecto exclusivo, e incorpora una tira ergonómica para el hombro y un asa suave y resistente para levantar el maletín cómodamente. Diseñado para garantizar la mejor protección para su portátil, el NE-L01 proporciona asimismo la máxima capacidad de almacenaje para plumas, lápices, carnets, documentos, reproductores de CD o MP3 y discos. Su sólida estructura y exterior resistente le garantizan un modelo para toda la vida.

Garantía del fabricante para toda la vida

Almacenaje inteligente
Max



Máxima protección para su portátil

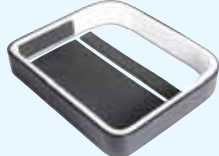

Diseño en forma de concha



Tira elástica ajustable al hombro



Bolsillo para los archivos



CARACTERÍSTICAS Y VENTAJAS

- A** Duradera confección realizada con armazón de nido de abeja
- B** Funda desmontable de tarjetas de visita
- C** Bolsillo de fácil acceso
- D** Exterior de piel auténtica
- E** Compartimento de apertura en acordeón para archivos

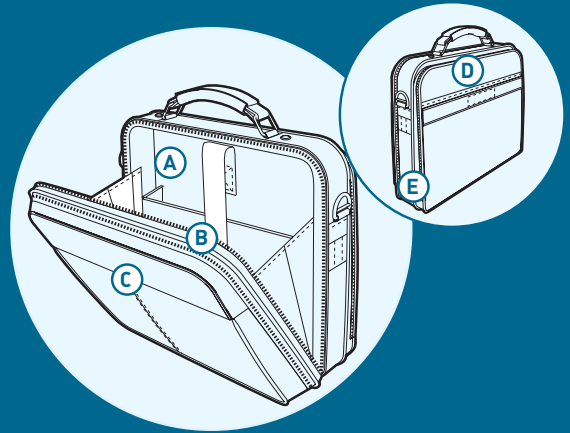

SISTEMA DE CLASIFICACIÓN NeuElements

1 2 3 4 5
Bueno Mejor

| | | | |
|--|-------------------------------|----------|---|
| | Duración | 5 | Nuestras series de primera línea NE hacen hincapié en su nylon balístico con el nuevo material Synthi2, que aporta lujo y resistencia. La microfibras y la napa armonizan nuestras mejores ediciones. |
| | Almacenaje inteligente | 5 | Los maletines NE proporcionan un almacenaje de sus artículos de negocios de fácil acceso; perfectos para usar en aeropuertos, salas de espera y oficinas en general. Las fundas de "quita y pon" añaden funcionalidad. |
| | Confort | 5 | La arquitectura NE enfatiza el confort para hacer sus viajes más cómodos. Proporcionando suaves tiras elásticas de neopreno, piel ergonómica no resbaladiza y asas de nylon, los maletines se manejan fácilmente incluso cuando están muy cargados. |
| | Protección | 5 | Nuestra excelente confección se focaliza en una meticulosa selección y evaluación del material. Para obtener la mejor protección contra posibles daños, usamos gruesos rellenos de espuma y marcos internos rígidos. |
| | Modo de vida | 5 | Los productos NE combinan tecnología y diseño para adaptarse a diversos modos de vida. Dejamos que la forma se encuentre con la funcionalidad y garantice una vida larga para nuestros maletines. |

ne NeuElements Infórmese sobre nuestra completa línea de bolsos

- **Serie ejecutivo**
Se beneficiará del sentido común y funcionalidad de nuestros duraderos diseños realizados con los mejores materiales.
- **Serie Sport para ejecutivos**
Estos resistentes modelos prolongan su tiempo de uso y prometen años de desplazamientos confortables y de confianza.
- **Serie estudio**
A la vanguardia con nuevos diseños que le proporcionan diseño y protección cuando se desplaza con sus herramientas de trabajo.

STUFF BAK StuffBak proporciona un completo servicio de protección anti-pérdidas que le ayuda a recuperar sus posesiones desaparecidas.

www.stuffbak.com

Su maletín NE de Belkin incluye nuestro carnet exclusivo, que indica a la persona que lo encuentre la forma de devolverlo fácilmente y obtener, además, una recompensa. Colocando una etiqueta StuffBak en cualquiera de sus importantes elementos puede facilitar su recuperación y evitar el desesperante procedimiento de objetos perdidos.



| | | |
|------------------------|------------------------|--|
| Número de pieza | Descripción | Adecuado para portátiles de hasta |
| F8L001ea | Maletín de piel NE-L01 | 368 x 305 x 51 cm |

Belkin Corporation
+1 310 898 1100
Compton • CA • EE.UU.
Belkin Ltd.
+44 (0) 1933 35 2000
Rushden • Reino Unido

Belkin B.V.
+31 (0) 20 654 7300
Schiphol-Rijk • Holanda
Belkin GmbH
+49 (0) 89 143405 0
München • Alemania

Belkin SAS
+33 (0) 1 41 03 14 40
Boulogne-Billancourt • Francia
Belkin Ltd.
+61 (0) 2 4372 8600
West Gosford • Australia

©2005 Belkin Corporation. Todos los derechos reservados. Todos los nombres comerciales son marcas registradas de los respectivos fabricantes enumerados.

BELKIN®

BORSA IN PELLE NE-L01

Per trasportare il notebook con la massima comodità



ne
NeuElements

Linea Executive



Nella borsa in pelle NE-L01 di Belkin potete trasportare tutti i vostri dispositivi elettronici necessari, contando sulla massima comodità durante gli spostamenti. L'aspetto di questa borsa si distingue per la pelle morbida e gli accattivanti tessuti utilizzati, cui si aggiunge una bretella ergonomica e morbida e un manico resistente. Progettata per garantire il massimo della protezione per il vostro notebook, la borsa NE-L01 prevede anche ampi spazi per riporre penne, matite, biglietti da visita, documenti, lettori CD o MP3 e dischetti. L'esterno resistente e la struttura robusta sono stati progettati per offrirvi una borsa di stile che dura una vita.

Garanzia a vita
del produttore



Spazio
intelligente



Massima
protezione
per il
portatile

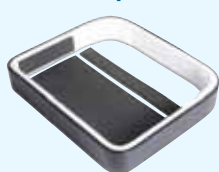

Apertura
a ribalta



Cinghia a
tracolla
elastica



Tasca a
soffietto
porta-
documenti



CARATTERISTICHE E VANTAGGI

- A** Struttura resistente a nido d'ape
- B** Tasca porta biglietto da visita rimovibile
- C** Tasca esterna facilmente accessibile
- D** Rivestimento in vera pelle
- E** Scomparto posteriore con soffietto per documenti

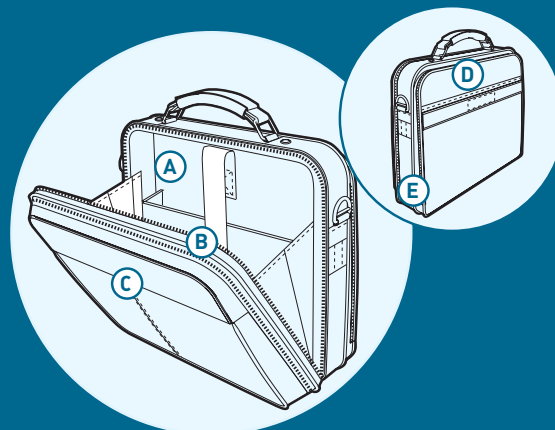

SISTEMA DI VALUTAZIONE NeuElements

1 2 3 4 5
Buono.....Ottimo



Resistenza

5

La linea NE combina nylon balistico con la nuova stoffa Synthi2, unendo così lusso e resistenza. L'unione tra microfibra e nappa caratterizza le nostre linee di lusso.



Spazio intelligente

5

Le borse NE offrono capienza a portata di mano per tutto l'indispensabile per gli affari. Sono perfette per essere usate in aeroporto, nelle sale d'attesa, in macchina e in altri uffici. Gli scomparti interni rimovibili aggiungono funzionalità.



Comfort

5

Il design NE accentua il comfort per agevolare i viaggi. Le borse sono comode anche quando sono completamente piene, grazie alle tracolle in morbido ed elastico neoprene ed ai manici antiscivolo in pelle o nylon.



Protezione

5

La nostra produzione si concentra sulla ricerca e la scelta meticolosa del materiale. Per garantire la migliore protezione dagli urti, usiamo uno spesso rivestimento in schiuma e un telaio interno rigido.



Stile di vita

5

I prodotti NE uniscono tecnologia ai design che si adattano agli stili di vita delle persone sempre in viaggio. Le nostre borse, che uniscono design e praticità, sono garantite a vita.

ne
NeuElements

Questa è la nostra gamma di borse

Linea Executive

Queste borse resistenti vi permettono di unire l'alta funzionalità ad un aspetto piacevole.

Linea Business Casual

Questi modelli ad alta resistenza durano nel tempo e vi garantiscono anni di trasporto comodo e affidabile.

Linea Studio

Folder dal design innovativo che conferiscono stile e protezione agli strumenti che portate con voi.



www.stuffbak.com

StuffBak garantisce una protezione diretta a prova di smarrimento ed un facile recupero della borsa. La borsa NE di Belkin è infatti marcata con il nostro unico contrassegno di identificazione che consente a chi la trovasse di restituirla facilmente e ricevere anche una ricompensa. Applicando l'etichetta StuffBak sulla vostra attrezzatura più importante, avete maggiori possibilità di rientrarne in possesso, evitando disperate ricerche negli Uffici Oggetti Smarriti.



Numero articolo Descrizione

F8L001ea

Borsa in pelle NE-L01

Progettata per trasportare notebook delle dimensioni massime di:

368 x 305 x 51 cm

Belkin Corporation

+1 310 898 1100

Compton • CA • USA

Belkin Ltd.

+44 (0) 1933 35 2000

Rushden • Regno Unito

Belkin B.V.

+31 (0) 20 654 7300

Schiphol-Rijk • Paesi Bassi

Belkin GmbH

+49 (0) 89 143405 0

Monaco di Baviera • Germania

Belkin SAS

+33 (0) 1 41 03 14 40

Boulogne-Billancourt • Francia

Belkin Ltd.

+61 (0) 2 4372 8600

West Gosford • Australia

©2005 Belkin Corporation. Tutti i diritti riservati. Tutti i nomi commerciali sono marchi registrati dai rispettivi produttori elencati.