



EN 300 328 v1.5.1 (2003-04)
as referenced by T.N. Cokenias Consulting Document Number
TNCAIRGOTP001 “Test Plan for Airgo Networks, Inc”

TEST REPORT

FOR

802.11b/g 2.4GHz TRUE MIMO BROADBAND GATEWAY

MODEL NUMBER: AIRGO AGN0901AP-01 and BELKIN F5D8230-4

REPORT NUMBER: 04U2926-6, Revision B1

ISSUE DATE: NOVEMBER 4, 2004

Prepared for
AIRGO NETWORKS INC.
900 ARASTRADERO ROAD
PALO ALTO, CA. 94304
USA

Prepared by
COMPLIANCE CERTIFICATION SERVICES
561F MONTEREY ROAD,
MORGAN HILL, CA 95037, USA
TEL: (408) 463-0885
FAX: (408) 463-0888



Revision History

<u>Rev.</u>	<u>Revisions</u>	<u>Revised By</u>
B	Added model numbers and referenced to the test plan "TNCAIRGOTP001"	Yan Zheng
B1	Added manufacturer names to the model numbers	Danielle Zhan

TABLE OF CONTENTS

1. TEST RESULT CERTIFICATION	4
2. EUT DESCRIPTION	5
2.1. DESCRIPTION OF EUT	5
2.2. MODEL DIFFERENCES	5
3. TEST METHODOLOGY	6
4. FACILITIES AND ACCREDITATION	6
5. CALIBRATION AND UNCERTAINTY	6
5.1. MEASURING INSTRUMENT CALIBRATION	6
5.2. MEASUREMENT UNCERTAINTY	6
5.3. TEST AND MEASUREMENT EQUIPMENT	7
6. SETUP OF EQUIPMENT UNDER TEST	8
7. EN 300 328 REQUIREMENTS	10
7.1. NORMAL AND EXTREME CONDITIONS	10
7.2. DUTY CYCLE	11
7.3. EFFECTIVE RADIATED POWER	12
7.4. SPECTRAL POWER DENSITY	15
7.5. FREQUENCY RANGE	23
7.6. SPURIOUS EMISSIONS	45
7.7. RECEIVER SPURIOUS EMISSIONS	53
8. SETUP PHOTOS	56

1. TEST RESULT CERTIFICATION

COMPANY NAME: AIRGO NETWORKS INC.
900 ARASTRADERO ROAD
PALO ALTO, CA. 94304
USA

EUT DESCRIPTION: 802.11b/g 2.4GHz TRUE MIMO BROADBAND GATEWAY

MODEL: AIRGO AGN0901AP-01 and BELKIN F5D8230-4

DATE TESTED: AUGUST 20 TO SEPTEMBER 10, 2004

APPLICABLE STANDARDS	
STANDARD	TEST RESULTS
EN 300 328 v1.5.1 as referenced by T.N. Cokenias Consulting Document Number TNCAIRGOTP001 “Test Plan for Airgo Networks, Inc”	NO NON-COMPLIANCE NOTED

Compliance Certification Services, Inc. tested the above equipment in accordance with the requirements set forth in the above standard. The test results show that the equipment tested is capable of demonstrating compliance with the requirements as documented in this report.

Note: This document reports conditions under which testing was conducted and results of tests performed. This document may not be altered or revised in any way unless done so by Compliance Certification Services and all revisions are duly noted in the revisions section. Any alteration of this document not carried out by Compliance Certification Services will constitute fraud and shall nullify the document.

Approved & Released For CCS By:



YAN ZHENG
EMC SUPERVISOR
COMPLIANCE CERTIFICATION SERVICES

Tested By:



VIEN TRAN
EMC ENGINEER
COMPLIANCE CERTIFICATION SERVICES

2. EUT DESCRIPTION

2.1. DESCRIPTION OF EUT

The EUT is an 802.11b/g true MIMO broadband gateway Access Point, which employs two transmitters and three receivers on radio cards.

The highest average conducted output power in each mode is as follows:

Frequency Band (MHz)	Mode	Output Power (dBm)	Output Power (mW)
2412 - 2472	802.11b	16.56	45.29
2412 - 2472	802.11g	16.58	45.50

The radio utilizes two MIMO system antennas for diversity, each with a maximum gain of 3 dBi.

The model number was changed after testing commenced. All data in this report is applicable to the model number documented in Section 1 above.

2.2. MODEL DIFFERENCES

The two models are identical, the two model numbers are used for marketing purpose only.

3. TEST METHODOLOGY

All tests were performed in accordance with the procedures documented in EN 300 328 v1.5.1 (2003-04) as referenced by T.N. Cokenias Consulting Document Number TNCAIRGOTP001 "Test Plan for Airgo Networks, Inc".

4. FACILITIES AND ACCREDITATION

The test sites and measurement facilities used to collect data are located at 561F Monterey Road, Morgan Hill, California, USA. The sites are constructed in conformance with the requirements of ANSI C63.4, ANSI C63.7 and CISPR Publication 22. All receiving equipment conforms to CISPR Publication 16-1, "Radio Interference Measuring Apparatus and Measurement Methods."

5. CALIBRATION AND UNCERTAINTY

5.1. MEASURING INSTRUMENT CALIBRATION

The measuring equipment utilized to perform the tests documented in this report has been calibrated in accordance with the manufacturer's recommendations, and is traceable to recognized national standards.

5.2. MEASUREMENT UNCERTAINTY

Where relevant, the following measurement uncertainty levels have been estimated for tests performed on the apparatus:

PARAMETER	UNCERTAINTY
Radio frequency	2.0×10^{-7}
Total RF power, conducted	0.71 dB
RF power density, conducted	2.9 dB
Spurious emissions, conducted	2.8 dB
All emissions, radiated	5.5 dB
Temperature	0.1 deg C
Humidity	1 % RH
DC and low frequency voltages	2 %

Uncertainty figures are valid to confidence level of 95% and follow ETR 028.

5.3. TEST AND MEASUREMENT EQUIPMENT

The following test and measurement equipment was utilized for the tests documented in this report:

TEST EQUIPMENT LIST				
Description	Manufacturer	Model	Serial Number	Cal Due
EMI Test Receiver	R & S	ESIB40	100192	11/21/04
Power Sensor, 100 kHz ~ 4.2 GHz	HP	8482A	2349A08568	1/16/06
Power Meter	HP	436A	2709A29209	1/16/06
Signal Generator, 10 MHz ~ 20 GHz	HP	83732B	US34490599	7/7/05
Oscilloscope, 100MHz 4Ch.	HP	54601A	3106A00123	2/5/05
Microwave Detector 0.01 ~ 50 GHz	Agilent	8474C	2905A04047	11/7/04
Temperature / Humidity Chamber	Thermotron	SE 600-10-10	29800	5/30/05
AC Power Source, 8KVA	APC	AFP2-8KVA	J5061	CNR
EMI Receiver, 9 kHz ~ 2.9 GHz	HP	8542E	3942A00286	11/21/04
RF Filter Section	HP	85420E	3705A00256	11/21/04
30MHz--- 2Ghz	Sunol Sciences	JB1 Antenna	A121003	12/22/04
Site A Preamplifier, 1300MHz	HP	8447D	2944A06833	8/18/05
Antenna, Horn 1 ~ 18 GHz	EMCO	3117	29301	12/26/04
Antenna, Horn 1 ~ 18 GHz	EMCO	3115	6717	2/4/05
Signal Generator, 2 ~ 40 GHz	R & S	SMP04	DE 34210	5/25/05
10 dB Attenuator	Weinschel	56-10	M2348	N/A

6. SETUP OF EQUIPMENT UNDER TEST

I/O CABLES

PERIPHERAL SUPPORT EQUIPMENT LIST				
Description	Manufacturer	Model	Serial Number	FCC ID
LAPTOP	DELL	PP08L	PP3373A01	N/A
AC ADAPTER	POTRANS	WD411200500	R030521	N/A
AC ADAPTER	DELL	NADP-90KB A	N/A	N/A

TEST SETUP

I/O CABLE LIST						
Cable No.	Port	# of Identical Ports	Connector Type	Cable Type	Cable Length	Remarks
1	AC	2	US115	UNSHIELDED	2m	NO
2	DC	2	DC	UNSHIELDED	2m	NO
3	Ethernet	1	RJ 45	UNSHIELDED	2m	To PC RJ45 Port

The EUT was controlled by the laptop via Ethernet cable. The test software exercised the radio card during tests.

SETUP DIAGRAM FOR TESTS

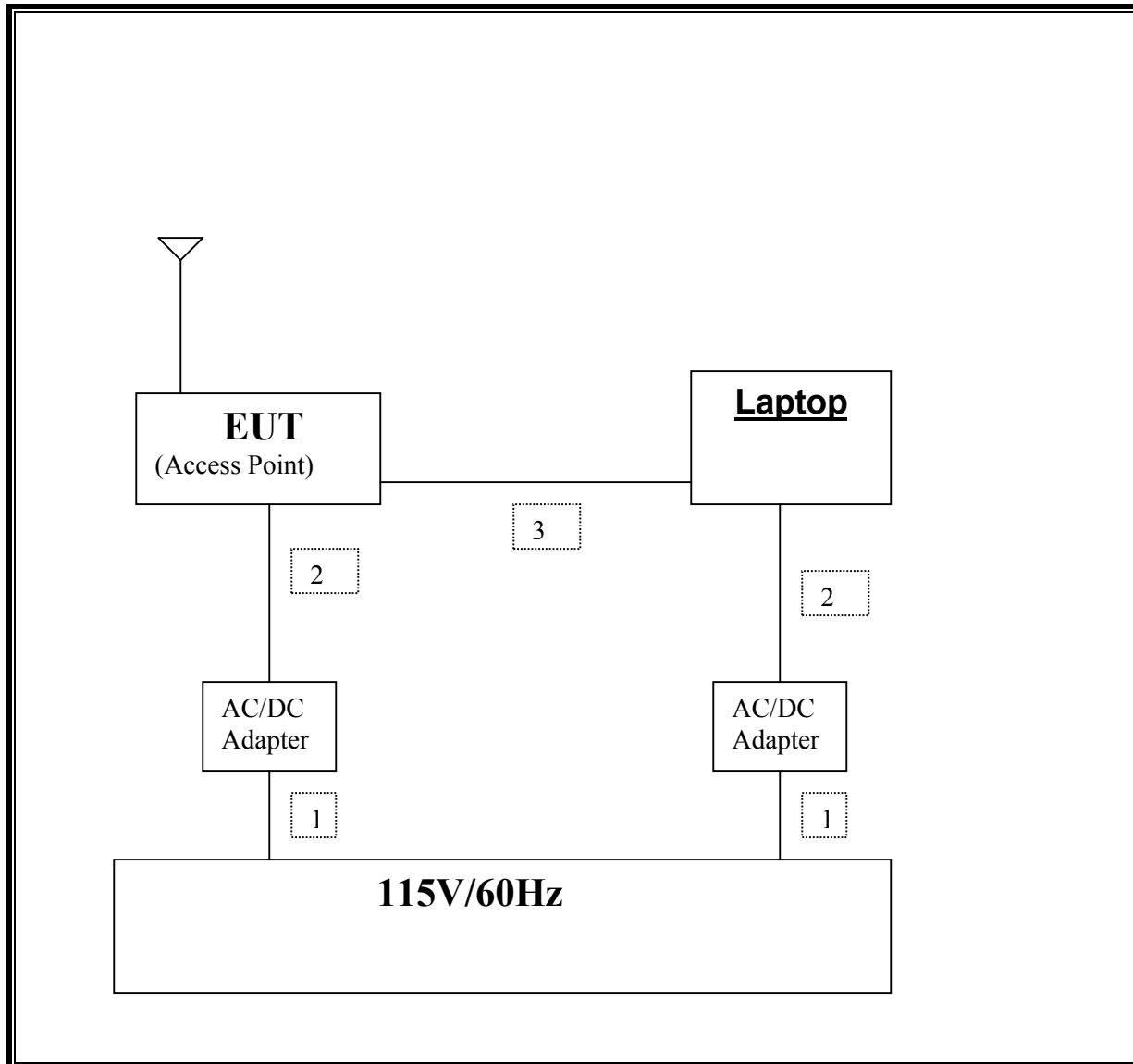

7. EN 300 328 REQUIREMENTS

7.1. NORMAL AND EXTREME CONDITIONS

LIMITS

None; for reporting purposes only.

RESULTS

Normal conditions are 25 deg C, 230 VAC.
The low temperature condition is 0 deg C.
The high temperature condition is 35 deg C.
The low voltage condition is 208 VAC.
The high voltage condition is 252 VAC.

7.2. DUTY CYCLE

LIMITS

None; for reporting purposes only.

RESULTS FOR 802.11b MODE

Tx on = 1.682 ms

Tx on + Tx off = 1.766 us

Duty Cycle x = 95.2 %

Duty Cycle Correction Factor = $10 * \log (1/x) = .21$ dB

RESULTS FOR 802.11g MODE

Tx on = 2.75ms

Tx on + Tx off = 2.91ms

Duty Cycle x = 94.8 %

Duty Cycle Correction Factor = $10 * \log (1/x) = .23$ dB

7.3. EFFECTIVE RADIATED POWER

LIMIT

EN 300 328 Clause 4.3.1

Radiated Power \leq 100 mW (20 dBm) EIRP over Normal and Extreme conditions.

TEST PROCEDURE

EN 300 328 Clause 5.7.2

CALCULATIONS

Output Power = Test Cable Loss + Duty Cycle Factor

EIRP = Output Power + EUT Antenna Gain

RESULTS

No non-compliance noted:

RESULTS FOR 802.11b MODE

Test Cable Loss (dB) =	15
Duty Cycle Factor (dB) =	0.21
EUT Antenna Gain (dBi) =	3

Condition	Measured Power (dBm)	Output Power (dBm)	EIRP (dBm)	Limit (dBm)	Margin (dB)
2412 MHz					
Normal	0.18	15.39	18.39	20	-1.61
Extreme T low, V low	1.62	16.83	19.83	20	-0.17
Extreme T low, V high	0.69	15.90	18.90	20	-1.10
Extreme T high V low	-0.04	15.17	18.17	20	-1.83
Extreme T high, V high	0.36	15.57	18.57	20	-1.43
2442 MHz					
Normal	1.35	16.56	19.56	20	-0.44
Extreme T low, V low	1.51	16.72	19.72	20	-0.28
Extreme T low, V high	0.86	16.07	19.07	20	-0.93
Extreme T high V low	1.26	16.47	19.47	20	-0.53
Extreme T high, V high	1.28	16.49	19.49	20	-0.51
2472 MHz					
Normal	0.16	15.37	18.37	20	-1.63
Extreme T low, V low	1.50	16.71	19.71	20	-0.29
Extreme T low, V high	0.49	15.70	18.70	20	-1.30
Extreme T high V low	0.29	15.50	18.50	20	-1.50
Extreme T high, V high	0.37	15.58	18.58	20	-1.42

RESULTS FOR 802.11g MODE

Test Cable Loss (dB) =	15
Duty Cycle Factor (dB) =	0.23
EUT Antenna Gain (dBi) =	3

Condition	Measured Power (dBm)	Output Power (dBm)	EIRP (dBm)	Limit (dBm)	Margin (dB)
2412 MHz					
Normal	0.75	15.98	18.98	20	-1.02
Extreme T low, V low	1.34	16.57	19.57	20	-0.43
Extreme T low, V high	0.78	16.01	19.01	20	-0.99
Extreme T high V low	0.30	15.53	18.53	20	-1.47
Extreme T high, V high	0.45	15.68	18.68	20	-1.32
2442 MHz					
Normal	1.35	16.58	19.58	20	-0.42
Extreme T low, V low	1.45	16.68	19.68	20	-0.32
Extreme T low, V high	0.84	16.07	19.07	20	-0.93
Extreme T high V low	1.10	16.33	19.33	20	-0.67
Extreme T high, V high	0.90	16.13	19.13	20	-0.87
2472 MHz					
Normal	0.60	15.83	18.83	20	-1.17
Extreme T low, V low	1.44	16.67	19.67	20	-0.33
Extreme T low, V high	0.90	16.13	19.13	20	-0.87
Extreme T high V low	1.00	16.23	19.23	20	-0.77
Extreme T high, V high	0.95	16.18	19.18	20	-0.82

7.4. SPECTRAL POWER DENSITY

LIMIT

EN 300 328 Clause 4.3.2

For modulation other than FHSS,
PPD \leq 10 mW (10 dBm) per MHz EIRP

TEST PROCEDURE

EN 300 328 Clause 5.7.3

The spectrum analyzer is equipped with a facility to measure power density.

The spectrum analyzer facility to measure power density was validated in accordance with CCSUT2802.

RESULTS

No non-compliance noted:

Power Density (dBm/MHz) EIRP =

Measured Power Density (dBm/Hz) + 60 (dB) + Duty Cycle Factor (dB) + EUT Antenna Gain (dBi)

EUT Antenna Gain (dBi) = 3

802.11b mode Duty Cycle Factor (dB) = 0.21				
Frequency (MHz)	Measured Density (dBm/Hz)	Power Density (dBm/MHz) EIRP	Limit (dBm/MHz) EIRP	Margin (dB)
2412	-53.23	9.98	10	-0.02
2442	-53.78	9.43	10	-0.57
2472	-54.49	8.72	10	-1.28

802.11g mode Duty Cycle Factor (dB) = 0.23				
Frequency (MHz)	Measured Density (dBm/Hz)	Power Density (dBm/MHz) EIRP	Limit (dBm/MHz) EIRP	Margin (dB)
2412	-54.30	8.93	10	-1.07
2442	-54.89	8.34	10	-1.66
2472	-54.91	8.32	10	-1.68

POWER DENSITY (802.11b MODE)

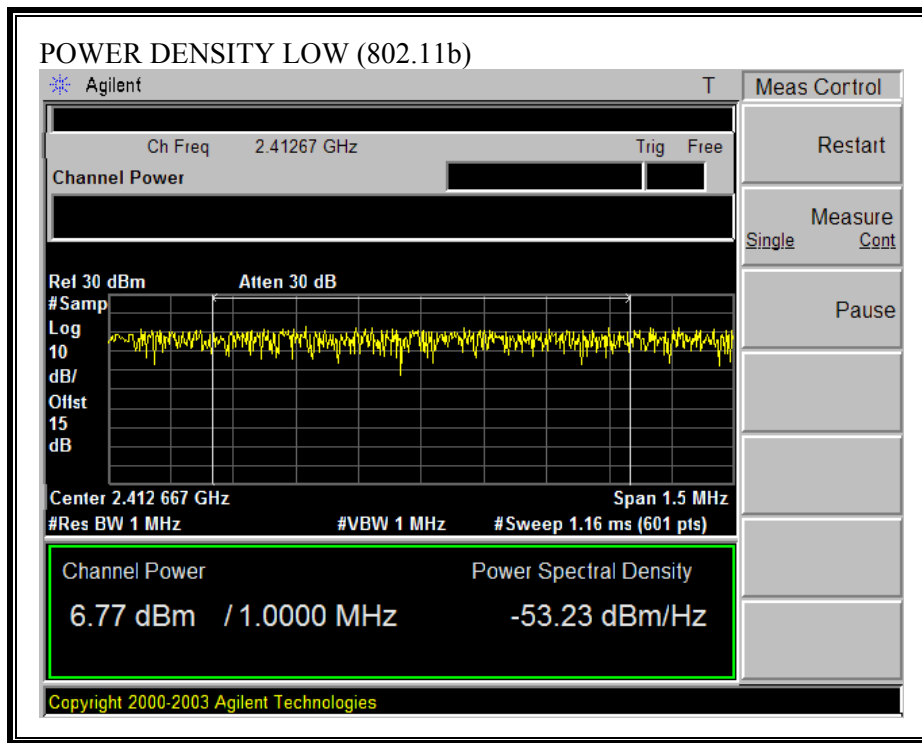

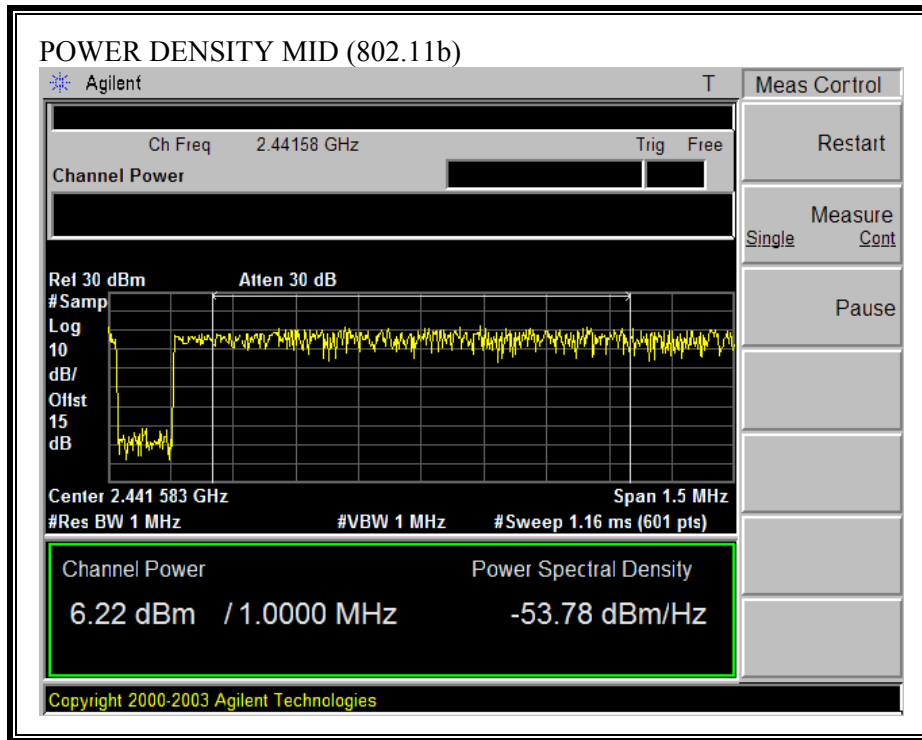

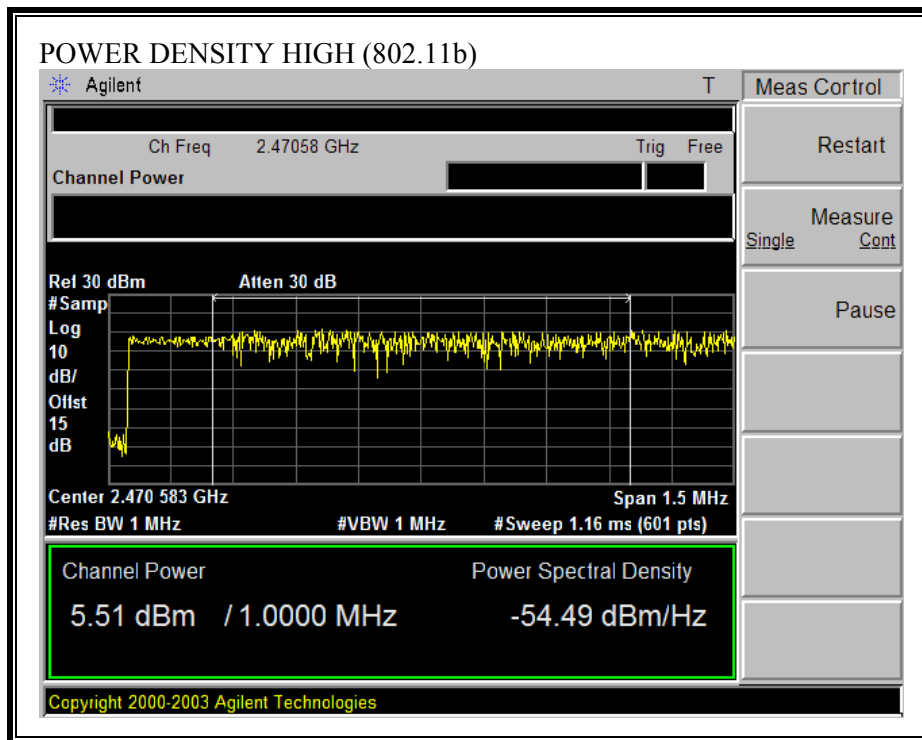

POWER DENSITY (802.11g MODE)

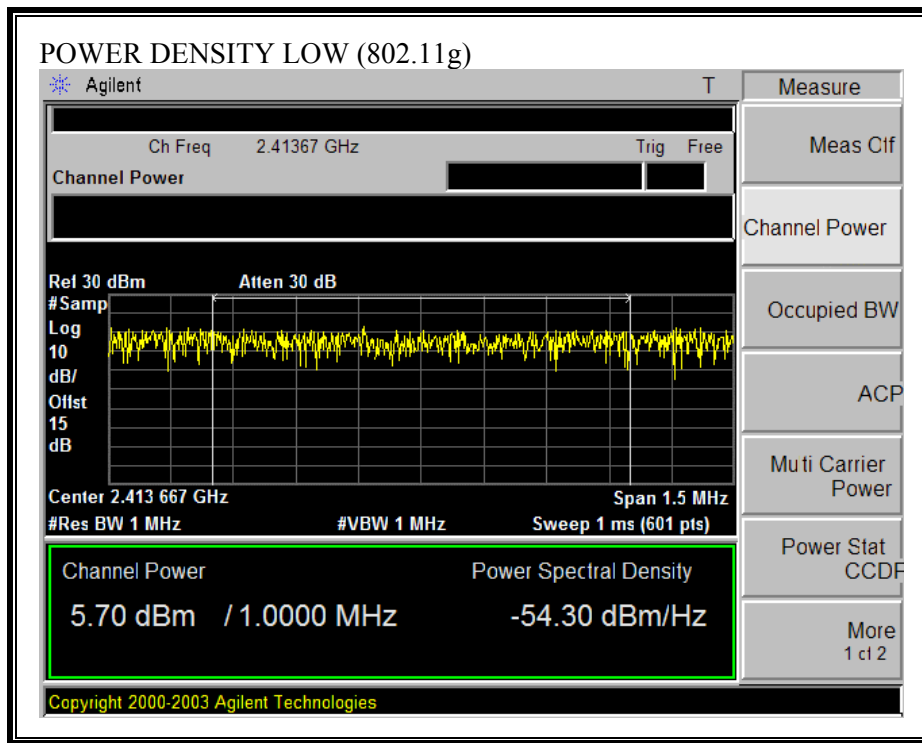

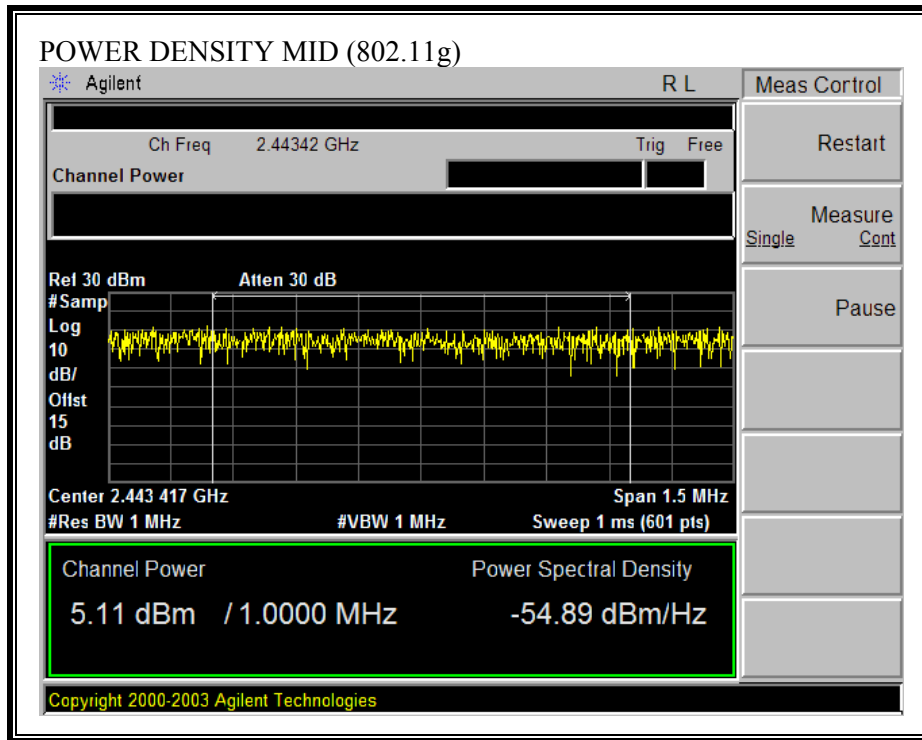

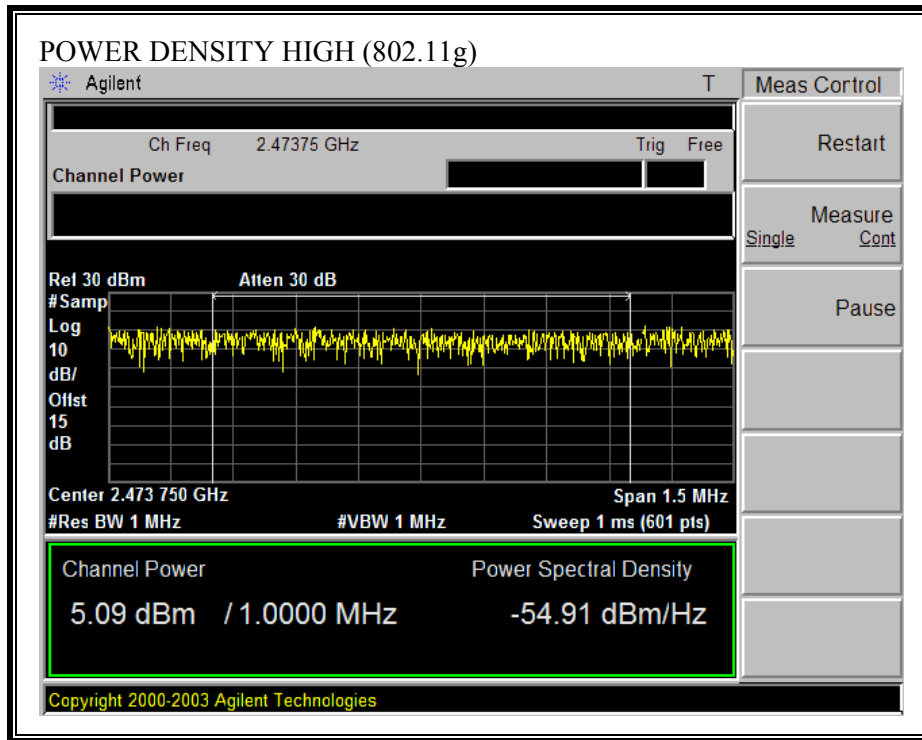

7.5. FREQUENCY RANGE

LIMIT

EN 300 328 Clause 4.3.3

The frequency range shall lie within the band 2.4 GHz to 2.4835 GHz ($f_L > 2.4$ GHz and $f_H < 2.4835$ GHz), over Normal and Extreme conditions.

TEST PROCEDURE

EN 300 328 Clause 5.7.4

RESULTS

No non-compliance noted:

RESULTS

802.11b Mode

Condition	F low (MHz)	Margin (MHz)	F high (MHz)	Margin (MHz)
Normal	2402.67	2.67	2481.42	2.08
Extreme T low, V low	2402.50	2.50	2481.58	1.92
Extreme T low, V high	2402.58	2.58	2481.58	1.92
Extreme T high V low	2402.75	2.75	2481.42	2.08
Extreme T high, V high	2402.67	2.67	2481.42	2.08

802.11g Mode

Condition	F low (MHz)	Margin (MHz)	F high (MHz)	Margin (MHz)
Normal	2403.17	3.17	2481.08	2.42
Extreme T low, V low	2403.00	3.00	2481.17	2.33
Extreme T low, V high	2403.00	3.00	2481.25	2.25
Extreme T high V low	2403.17	3.17	2480.82	2.68
Extreme T high, V high	2403.17	3.17	2481.00	2.50

FREQUENCY RANGE F LOW (802.11b MODE)

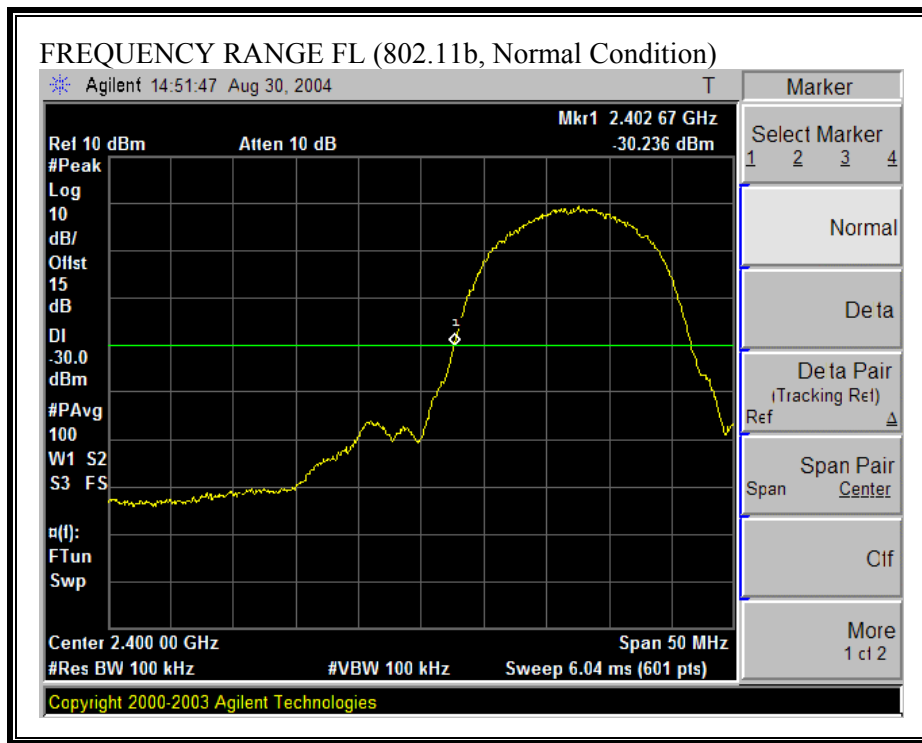

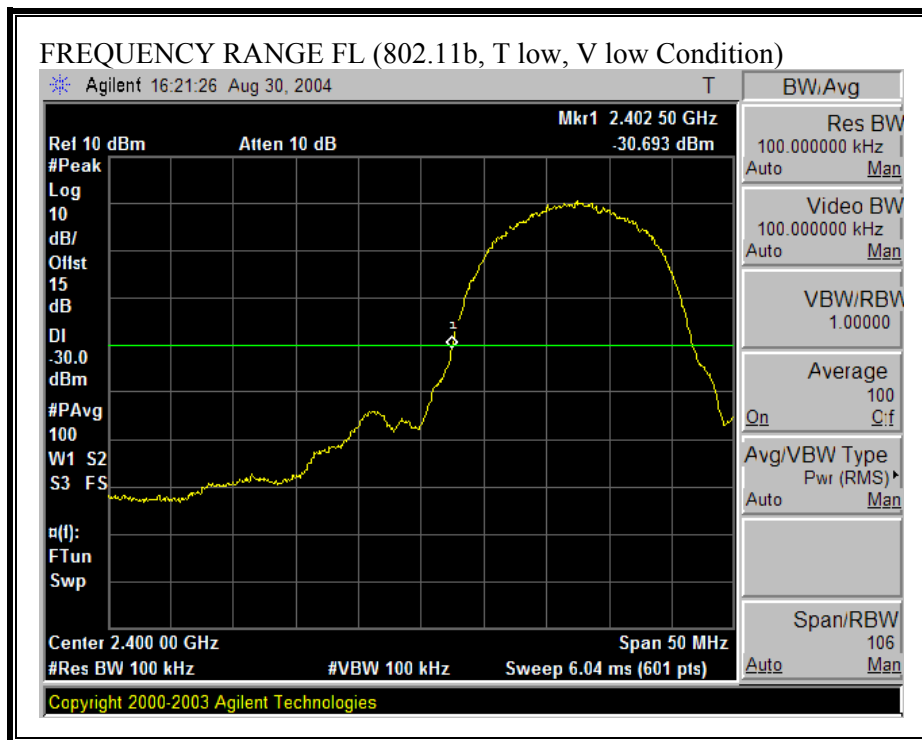

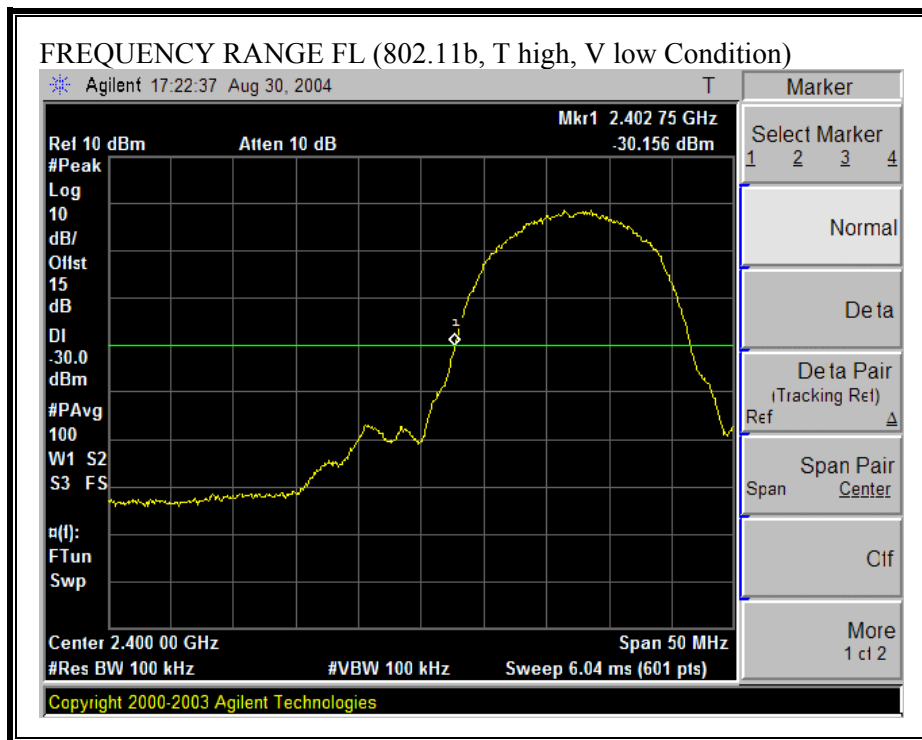

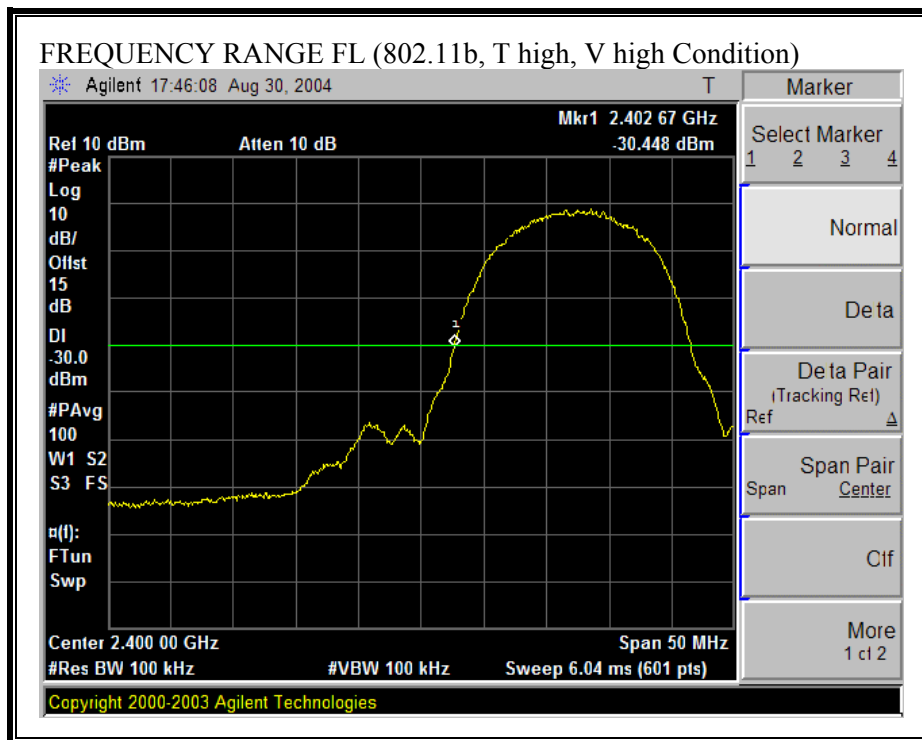

FREQUENCY RANGE F HIGH (802.11b MODE)

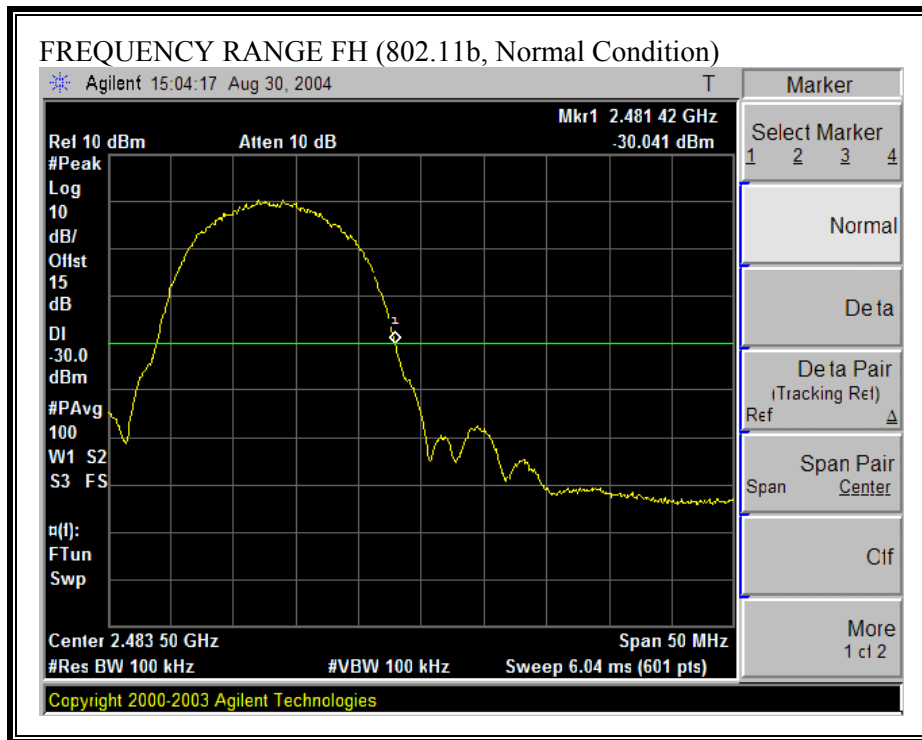

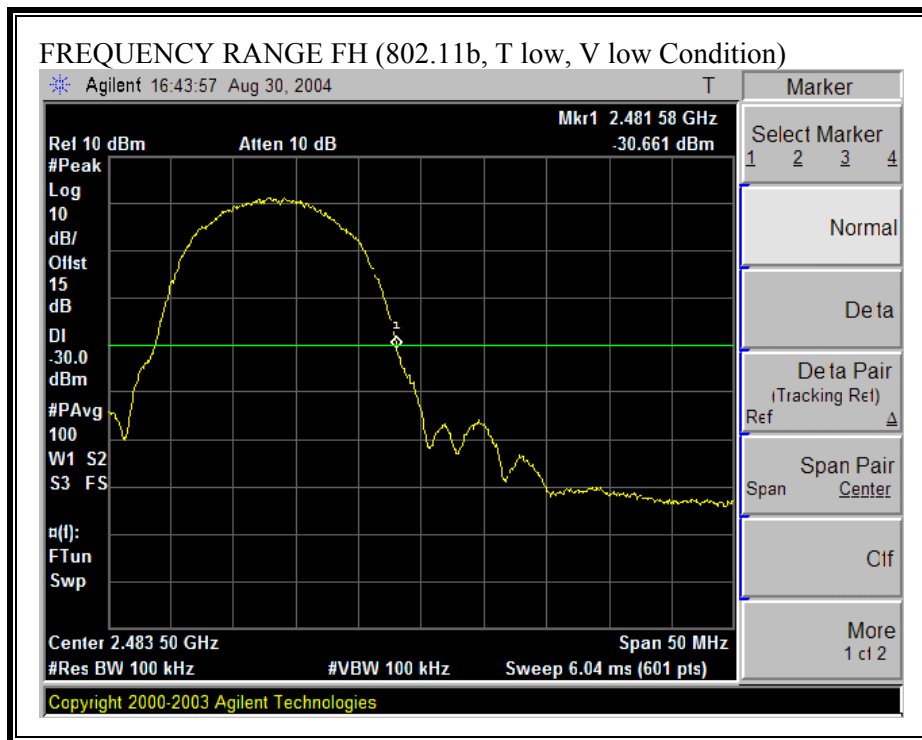

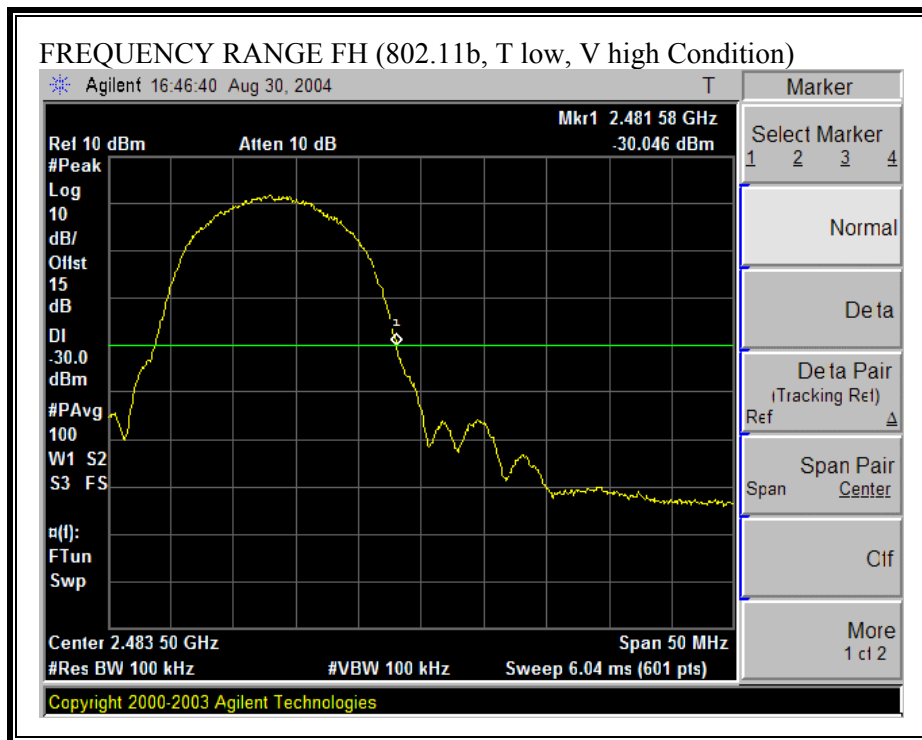

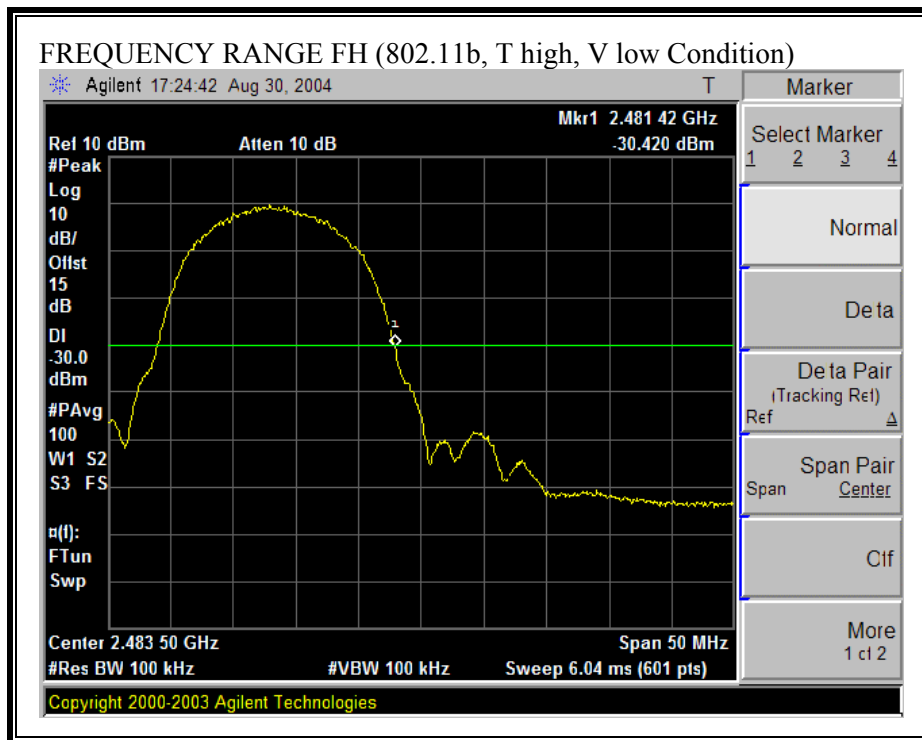

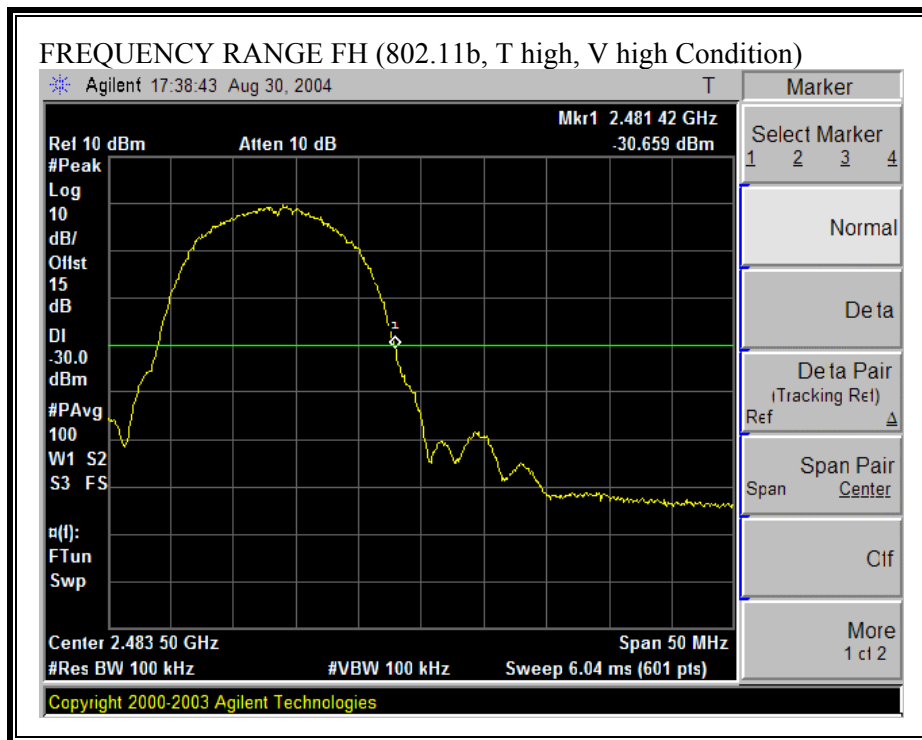

FREQUENCY RANGE F LOW (802.11g MODE)

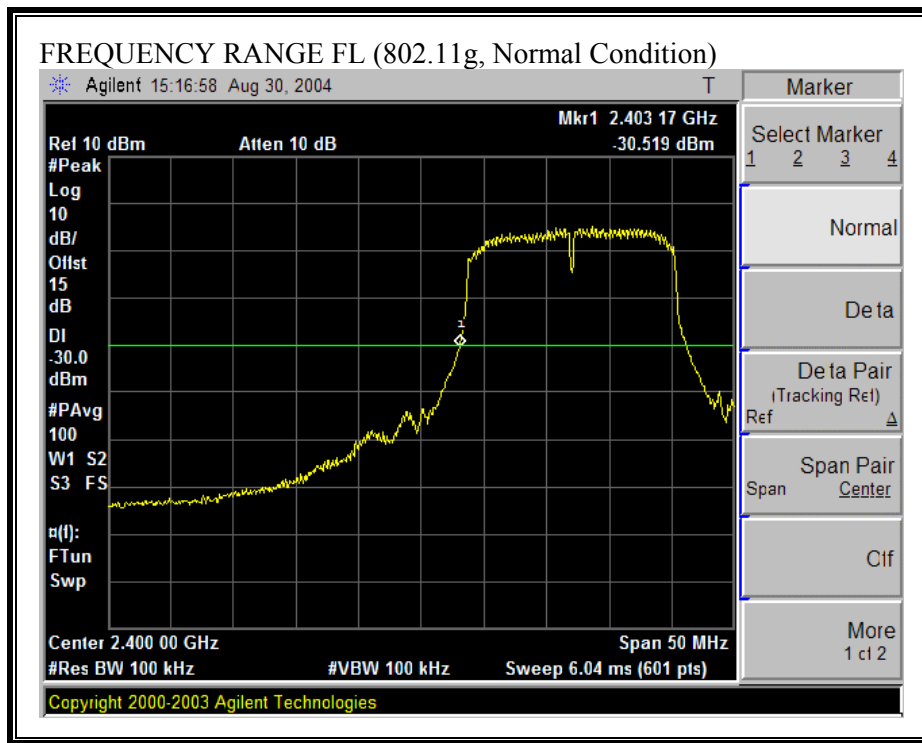

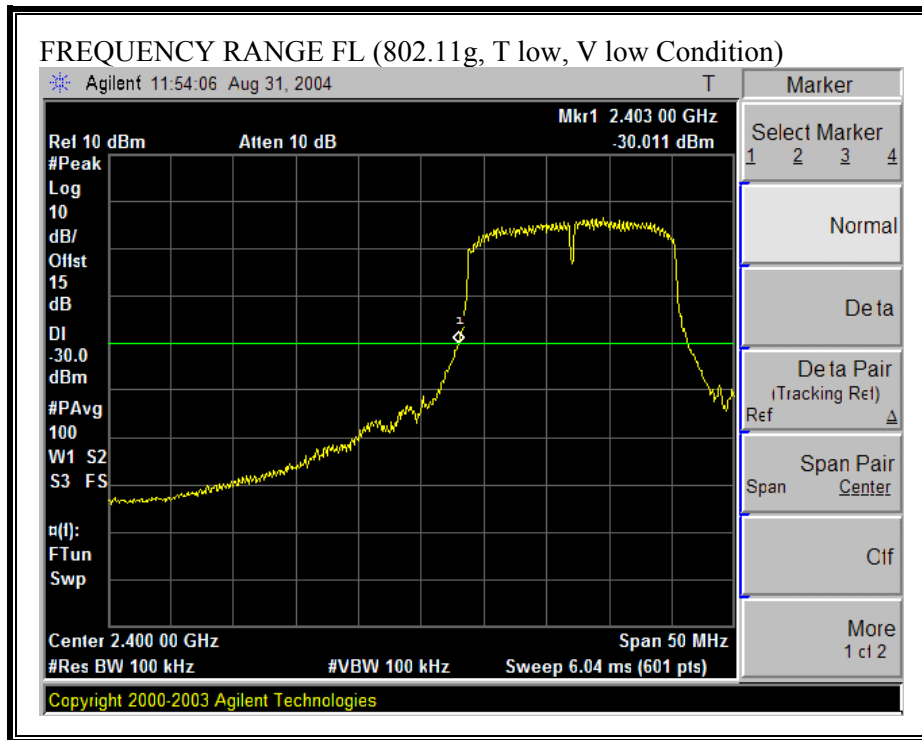

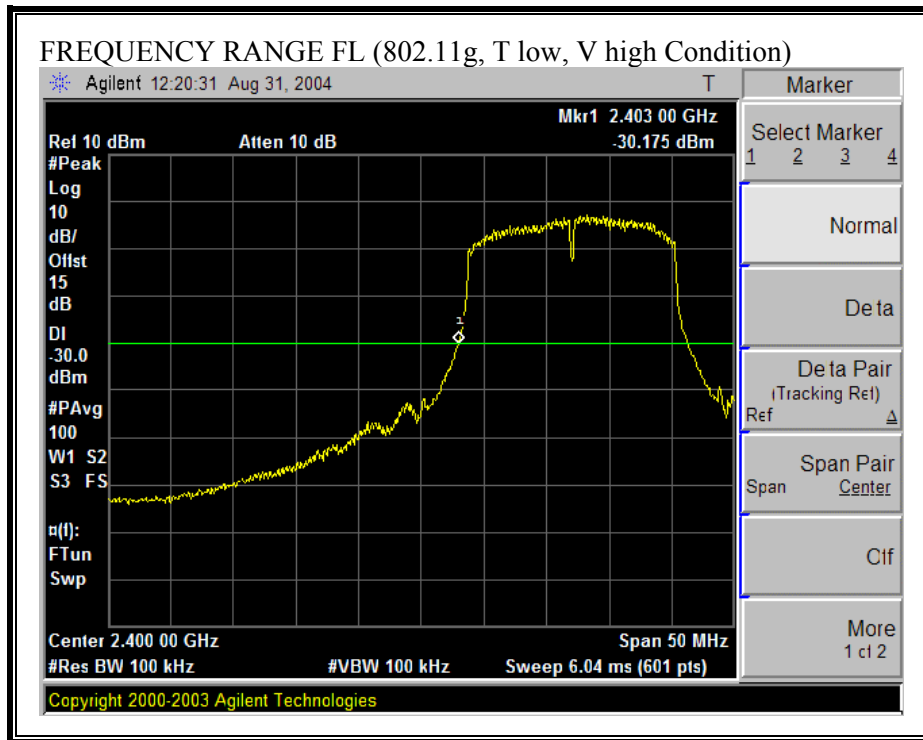

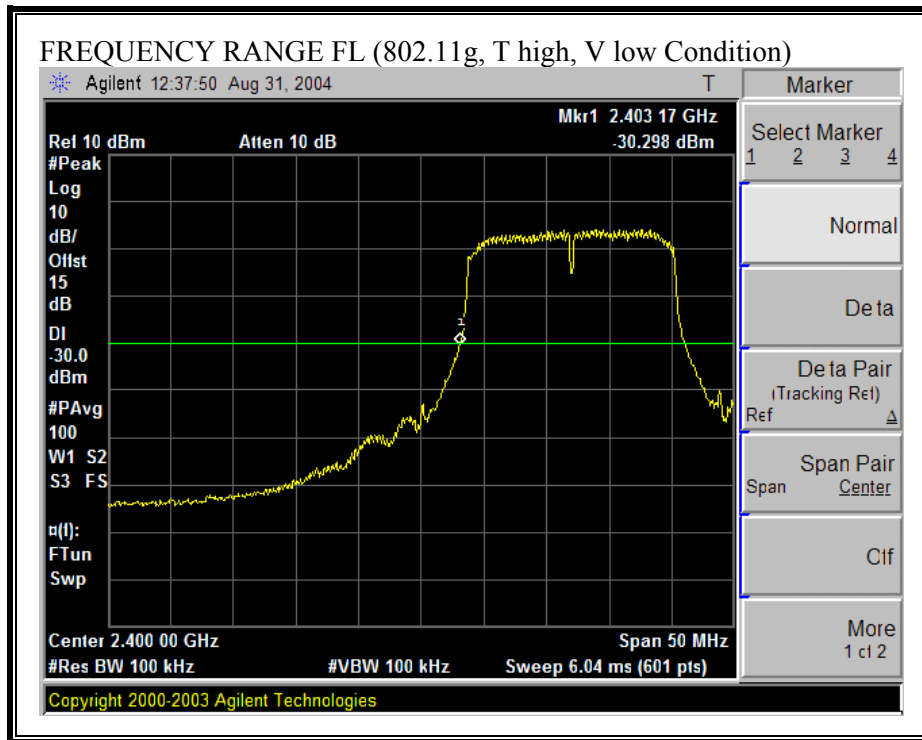

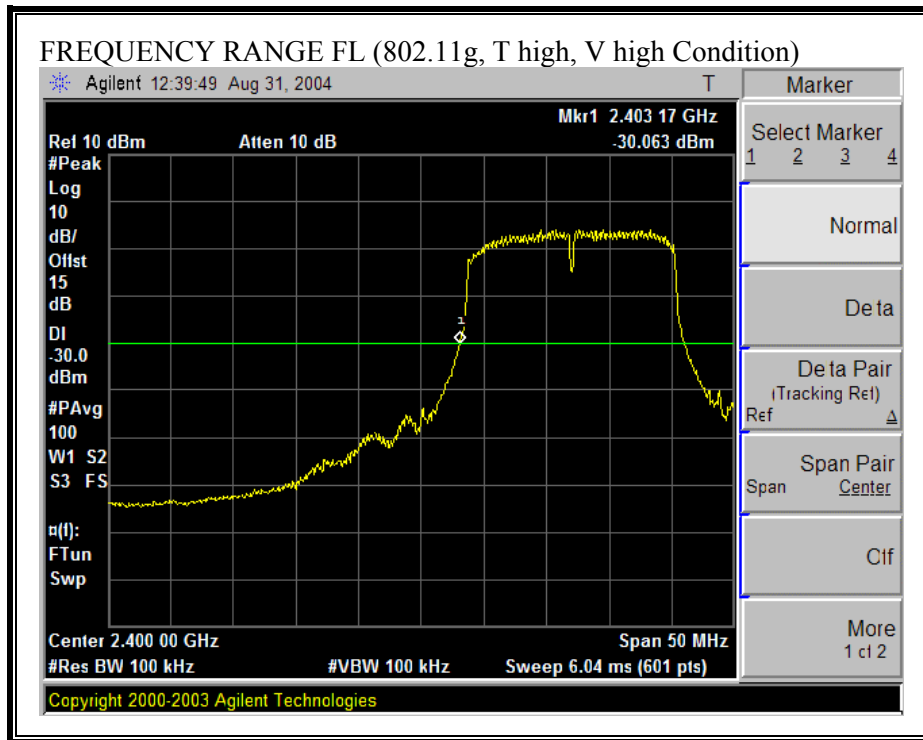

FREQUENCY RANGE F HIGH (802.11g MODE)

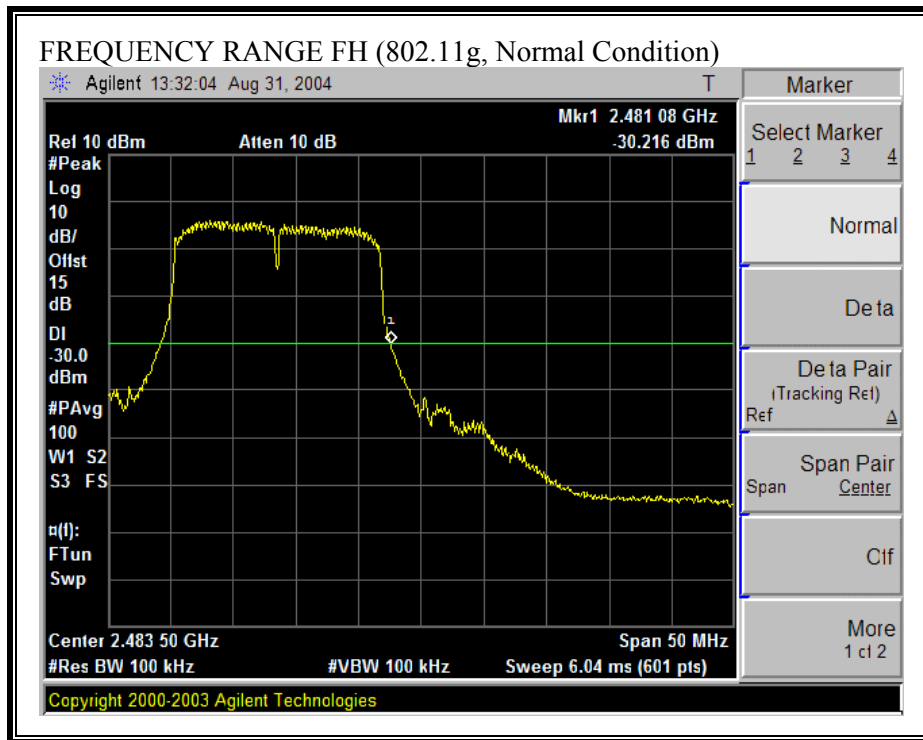

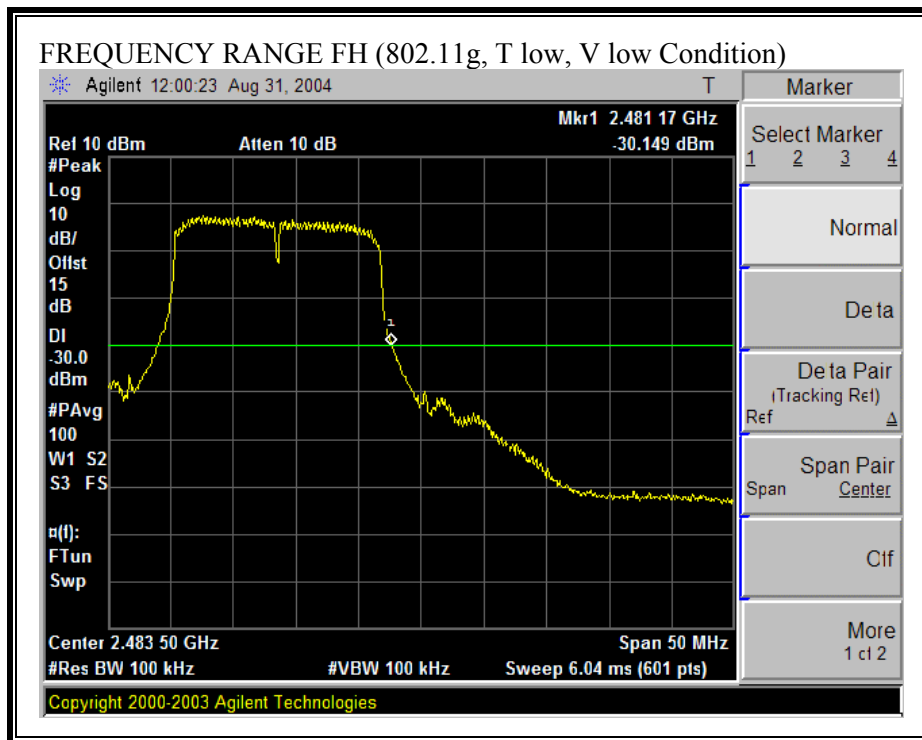

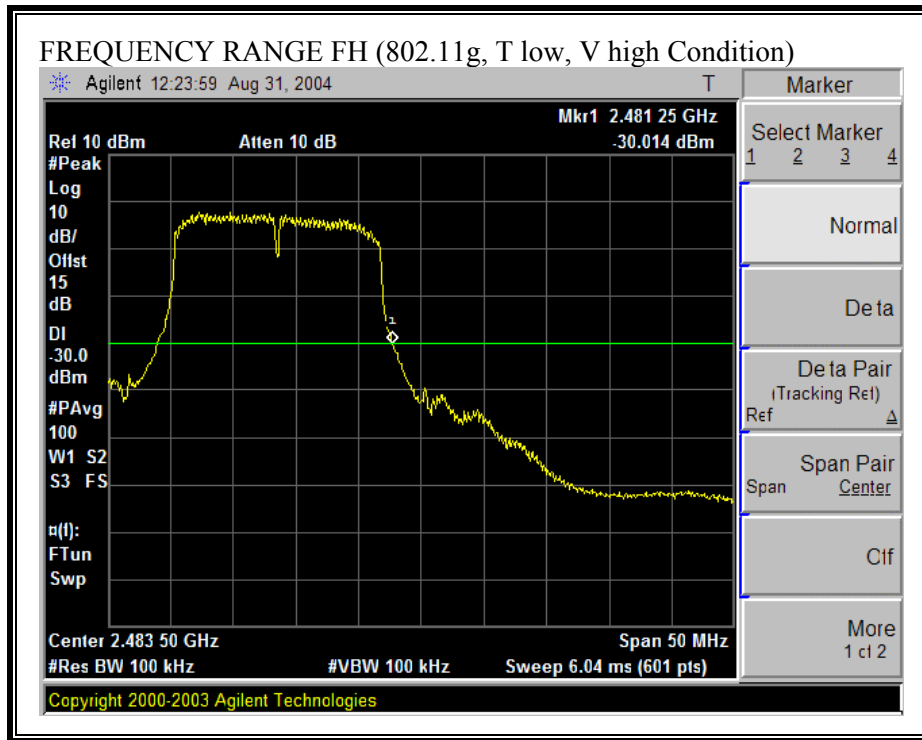

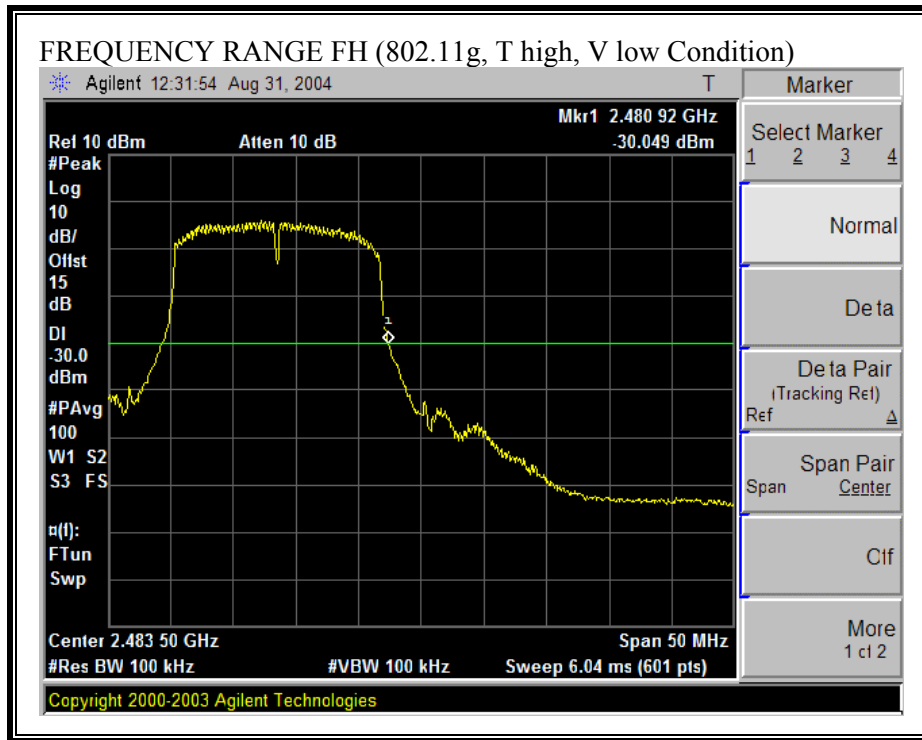

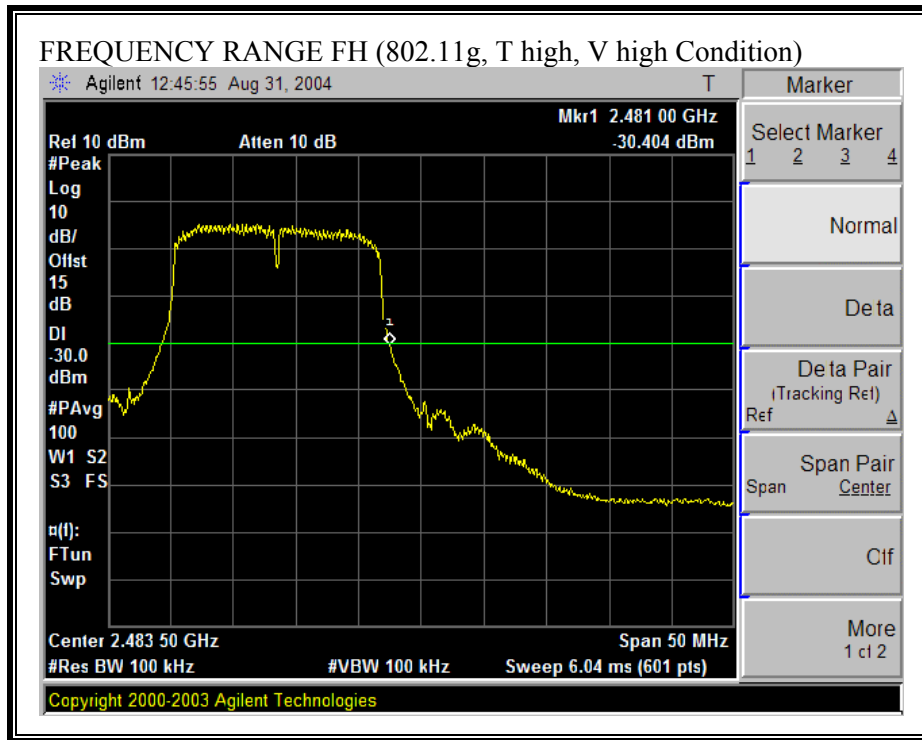

7.6. SPURIOUS EMISSIONS

LIMIT

EN 300 328 Clause 4.3.4

Table 2: Transmitter Limits for Narrowband Spurious Emissions

Frequency Range	Limit when operating	Limit when in standby
30 MHz to 1.0 GHz	-36 dBm	-57 dBm
1.0 GHz to 12.75 GHz	-30 dBm	-47 dBm
1.8 GHz to 1.9 GHz 5.15 GHz to 5.3 GHz	-47 dBm	-47 dBm

Table 3: Transmitter Limits for Wideband Spurious Emissions

Frequency Range	Limit when operating	Limit when in standby
30 MHz to 1.0 GHz	-86 dBm/Hz	-107 dBm/Hz
1.0 GHz to 12.75 GHz	-80 dBm/Hz	-97 dBm/Hz
1.8 GHz to 1.9 GHz 5.15 GHz to 5.3 GHz	-97 dBm/Hz	-97 dBm/Hz

TEST PROCEDURE

EN 300 328 Clause 5.7.5

OPERATING MODE TEST PROTOCOL

EN 300 328 Clause 5.7.5

The level of spurious emissions are measured as their effective radiated power when radiated by antenna.

RESULTS

No non-compliance noted:

RADIATED SPURIOUS EMISSIONS BELOW 1 GHz B MODE LOW CHANNEL

9/7/2004 Below 1GHz Frequency Measurement
 Compliance Certification Services, Mogan Hill Open Field Site

Test Engineer: David Garcia
Project#: 04U2926
Company: AirGo
EUT Description: 802.11B/G 2.4GHz BELIKAN GATEWAY
EUT M/N: TBD
Test Target: ETSI 300 328
Mode Operate: B Mode, Low Channel, Tx

Test Equipment:

Adjustable Dipole
 EMCO T73 S/N 6717

Pre-amplifier 0.9-1.3GH
 T5,8447D

EMI Receiver
 8542E

Signal Generator
 R&S SMP04

Frequency (MHz)	Reading level (dBuV)	Antenna Polarization	S.G. (dBm)	Cable loss (dB)	Ant.Gain (dBi)	Emission level (dBm)	Limit (dBm)	Margin (dB)
103.72	50.32	H	-64.87	0.69	0.05	-64.13	-36.00	-28.13
147.37	48.46	H	-64.36	0.88	-2.09	-65.57	-36.00	-29.57
203.63	49.29	H	-64.90	1.15	-1.10	-64.85	-36.00	-28.85
256.98	54.30	H	-58.50	1.32	1.05	-56.13	-36.00	-20.13
382.11	46.34	H	-64.94	1.72	1.41	-61.81	-36.00	-25.81
567.38	53.47	H	-55.69	2.27	1.19	-52.23	-36.00	-16.23

Frequency (MHz)	Reading level (dBuV)	Antenna Polarization	S.G. (dBm)	Cable loss (dB)	Ant.Gain (dBi)	Emission level (dBm)	Limit (dBm)	Margin (dB)
40.67	45.88	V	-54.34	0.27	-10.37	-64.44	-36.00	-28.44
54.25	48.31	V	-52.54	0.40	-6.68	-58.82	-36.00	-22.82
256.98	54.74	V	-57.29	1.32	1.05	-54.92	-36.00	-18.92
383.08	46.55	V	-61.72	1.72	1.41	-58.59	-36.00	-22.59
567.38	48.87	V	-58.87	2.27	1.19	-55.41	-36.00	-19.41
632.37	45.85	V	-61.06	2.43	0.90	-57.72	-36.00	-21.72

RADIATED SPURIOUS EMISSIONS BELOW 1 GHz B MODE HIGH CHANNEL

9/7/2004 Below 1GHz Frequency Measurement
 Compliance Certification Services, Mogan Hill Open Field Site

Test Engineer: David Garcia
 Project#: 04U2926
 Company: AirGo
 EUT Description: 802.11B/G 2.4GHz BELIKAN GATEWAY
 EUT M/N: TBD
 Test Target: ETSI 300 328
 Mode Operate: B Mode, High Channel, Tx

Test Equipment:

Adjusttable Dipole
 EMCO T73 S/N 6717

Pre-amplifier 0.9-1.3GH
 T5,8447D

EMI Receiver
 8542E

Signal Generator
 R&S SMP04

Frequency (MHz)	Reading level (dBuV)	Antenna Polarization	S.G. (dBm)	Cable loss (dB)	Ant.Gain (dBi)	Emission level (dBm)	Limit (dBm)	Margin (dB)
106.63	51.61	H	-63.86	0.71	0.32	-62.83	-36.00	-26.83
148.34	48.46	H	-64.36	0.88	-2.09	-65.57	-36.00	-29.57
256.98	55.47	H	-57.33	1.32	1.05	-54.96	-36.00	-18.96
383.08	47.48	H	-63.80	1.72	1.41	-60.67	-36.00	-24.67
591.63	49.33	H	-59.81	2.33	0.98	-56.50	-36.00	-20.50
740.04	43.91	H	-64.65	2.64	0.74	-61.27	-36.00	-25.27

Frequency (MHz)	Reading level (dBuV)	Antenna Polarization	S.G. (dBm)	Cable loss (dB)	Ant.Gain (dBi)	Emission level (dBm)	Limit (dBm)	Margin (dB)
53.28	44.37	V	-56.48	0.40	-6.68	-62.76	-36.00	-26.76
148.34	49.97	V	-57.29	0.88	-2.09	-58.50	-36.00	-22.50
256.98	51.47	V	-60.56	1.32	1.05	-58.19	-36.00	-22.19
382.11	46.85	V	-61.42	1.72	1.41	-58.29	-36.00	-22.29
591.63	47.09	V	-59.74	2.33	0.98	-56.43	-36.00	-20.43
633.34	44.36	V	-62.55	2.44	0.91	-59.21	-36.00	-23.21
740.04	41.25	V	-69.13	2.64	0.74	-65.75	-36.00	-29.75

RADIATED SPURIOUS EMISSIONS BELOW 1 GHz G MODE LOW CHANNEL

9/7/2004 Below 1GHz Frequency Measurement
 Compliance Certification Services, Mogan Hill Open Field Site

Test Engineer: David Garcia
 Project#: 04U2926
 Company: AirGo
 EUT Description: 802.11B/G 2.4GHz BELIKAN GATEWAY
 EUT M/N: TBD
 Test Target: ETSI 300 328
 Mode Operate: G Mode, Low Channel, Tx

Test Equipment:

Adjusttable Dipole
 EMCO T73 S/N 6717

Pre-amplifier 0.9-1.3GH
 T5,8447D

EMI Receiver
 8542E

Signal Generator
 R&S SMP04

Frequency (MHz)	Reading level (dBuV)	Antenna Polarization	S.G. (dBm)	Cable loss (dB)	Ant.Gain (dBi)	Emission level (dBm)	Limit (dBm)	Margin (dB)
46.49	42.09	H	-51.85	0.32	-8.67	-60.20	-36.00	-24.20
106.63	51.68	H	-63.79	0.71	0.32	-62.76	-36.00	-26.76
256.98	54.46	H	-58.34	1.32	1.05	-55.97	-36.00	-19.97
383.08	48.30	H	-62.98	1.72	1.41	-59.85	-36.00	-23.85
567.38	52.98	H	-56.18	2.27	1.19	-52.72	-36.00	-16.72
736.16	42.61	H	-65.96	2.62	0.76	-62.57	-36.00	-26.57

Frequency (MHz)	Reading level (dBuV)	Antenna Polarization	S.G. (dBm)	Cable loss (dB)	Ant.Gain (dBi)	Emission level (dBm)	Limit (dBm)	Margin (dB)
53.28	46.68	V	-54.17	0.40	-6.68	-60.45	-36.00	-24.45
256.01	51.25	V	-60.78	1.32	1.05	-58.41	-36.00	-22.41
381.14	47.24	V	-61.02	1.71	1.40	-57.91	-36.00	-21.91
565.44	51.05	V	-56.68	2.26	1.18	-53.24	-36.00	-17.24
630.43	45.14	V	-61.77	2.43	0.90	-58.44	-36.00	-22.44
740.04	43.79	V	-62.44	2.64	0.74	-59.06	-36.00	-23.06

RADIATED SPURIOUS EMISSIONS BELOW 1 GHz G MODE HIGH CHANNEL

9/7/2004 Below 1GHz Frequency Measurement
 Compliance Certification Services, Mogan Hill Open Field Site

Test Engineer: David Garcia
Project#: 04U2926
Company: AirGo
EUT Description: 802.11B/G 2.4GHz BELIKAN GATEWAY
EUT M/N: TBD
Test Target: ETSI 300 328
Mode Operate: G Mode, High Channel, Tx

Test Equipment:

Adjusttable Dipole
 EMCO T73 S/N 6717

Pre-amplifier 0.9-1.3GH
 T5,8447D

EMI Receiver
 8542E

Signal Generator
 R&S SMP04

Frequency (MHz)	Reading level (dBuV)	Antenna Polarization	S.G. (dBm)	Cable loss (dB)	Ant.Gain (dBi)	Emission level (dBm)	Limit (dBm)	Margin (dB)
106.63	51.78	H	-63.69	0.71	0.32	-62.66	-36.00	-26.66
256.98	54.21	H	-58.59	1.32	1.05	-56.22	-36.00	-20.22
383.08	47.42	H	-63.86	1.72	1.41	-60.73	-36.00	-24.73
594.54	49.11	H	-60.03	2.33	0.98	-56.72	-36.00	-20.72
740.04	44.03	H	-64.53	2.64	0.74	-61.15	-36.00	-25.15

Frequency (MHz)	Reading level (dBuV)	Antenna Polarization	S.G. (dBm)	Cable loss (dB)	Ant.Gain (dBi)	Emission level (dBm)	Limit (dBm)	Margin (dB)
53.28	45.87	V	-54.98	0.40	-6.68	-61.26	-36.00	-25.26
149.31	49.83	V	-57.44	0.89	-2.08	-58.63	-36.00	-22.63
256.98	52.20	V	-59.83	1.32	1.05	-57.46	-36.00	-21.46
383.08	47.23	V	-61.04	1.72	1.41	-57.91	-36.00	-21.91
594.54	47.14	V	-59.70	2.33	0.98	-56.38	-36.00	-20.38
633.34	44.97	V	-61.94	2.44	0.91	-58.60	-36.00	-22.60

RADIATED SPURIOUS EMISSIONS ABOVE 1 GHz (b MODE)

08/27/04 **High Frequency Substitution Measurement**
 Compliance Certification Services, Morgan Hill 5m Chamber Site

Test Engr: NEELESH RAJ
Project #: 04U2926-6
Company: AIRGO
EUT Descrip.: 802.11B/G 2.4GHz BELIKAN GATEWAY (COMPLETE SYSTEM)
EUT M/N: TBD
Test Target: ETSI328
Mode Oper: TX (B MODE)

Test Equipment:

EMCO Horn 1-18GHz Horn > 18GHz Limit High Pass Filter
 T73; S/N: 6717 @3m ETSI 300 328 Tx

RHODE AND SCHWARZ RECEIVER
 Hi Frequency Cables
 (2 ft) (2 ~ 3 ft) (4 ~ 6 ft) (12 ft)

Pre-amplifer 1-26GHz Pre-amplifer 26-40GHz
 T86 Miteq 924341

f GHz	SA reading (dBuV/m)	Ant. Pol. (H/V)	SG reading (dBm)	CL (dB)	Gain (dBi)	Gain (dBd)	ERP (dBm)	Limit (dBm)	Margin (dB)	Notes
LOW CHANNEL										
4.824	47.0	V	-57.5	3.2	10.5	8.3	-52.4	-30.0	-22.4	
4.824	39.3	H	-64.8	3.2	10.5	8.3	-59.8	-30.0	-29.8	
							0.0			
HIGH CHANNEL										
4.944	51.5	V	-53.0	3.3	10.6	8.4	-47.8	-30.0	-17.8	
4.944	47.2	H	-56.9	3.3	10.6	8.4	-51.7	-30.0	-21.7	
NO OTHER SPURIOUS EMISSIONS DETECTED ABOVE THE SYSTEM NOISE FLOOR FROM THE TRANSMITTER										

RADIATED SPURIOUS EMISSIONS ABOVE 1 GHz (g MODE)

08/27/04 **High Frequency Substitution Measurement**
 Compliance Certification Services, Morgan Hill 5m Chamber Site

Test Engr: NEELESH RAJ
Project #: 04U2926-6
Company: AIRGO
EUT Descrip.: 802.11B/G 2.4GHz BELIKAN GATEWAY (COMPLETE SYSTEM)
EUT M/N: TBD
Test Target: ETSI328
Mode Oper: TX (G.MODE)

Test Equipment:

EMCO Horn 1-18GHz Horn > 18GHz Limit High Pass Filter
 T73; S/N: 6717 @3m ETSI 300 328 Tx

RHODE AND SCHWARZ RECEIVER
 Hi Frequency Cables
 (2 ft) (2 ~ 3 ft) (4 ~ 6 ft) (12 ft)

Pre-amplifier 1-26GHz Pre-amplifier 26-40GHz
 T86 Miteq 924341

f GHz	SA reading (dBuV/m)	Ant. Pol. (H/V)	SG reading (dBm)	CL (dB)	Gain (dBi)	Gain (dBd)	ERP (dBm)	Limit (dBm)	Margin (dB)	Notes
LOW CHANNEL										
4.824	42.5	V	-62.0	3.2	10.5	8.3	-56.9	-30.0	-26.9	
4.824	43.5	H	-60.6	3.2	10.5	8.3	-55.6	-30.0	-25.6	
							0.0			
HIGH CHANNEL										
4.944	43.1	V	-61.3	3.3	10.6	8.4	-56.2	-30.0	-26.2	
4.944	42.7	H	-61.4	3.3	10.6	8.4	-56.2	-30.0	-26.2	
NO OTHER SPURIOUS EMISSIONS DETECTED ABOVE THE SYSTEM NOISE FLOOR FROM THE TRANSMITTER										

STANDBY MODE TEST PROTOCOL

The standby mode is identical to the receive mode. See Receiver Spurious Emissions results.

ETSI EN 300 328 Clause 5.7.5

The level of spurious emissions are measured as their effective radiated power when radiated by antenna.

RESULTS

No non-compliance noted:

7.7. RECEIVER SPURIOUS EMISSIONS

LIMIT

EN 300 328 Clause 4.3.5

Table 4: Narrowband Spurious Emissions Limits for Receivers

Frequency Range	Limit
30 MHz to 1.0 GHz	-57 dBm
1.0 GHz to 12.75 GHz	-47 dBm

Table 5: Wideband Spurious Emissions Limits for Receivers

Frequency Range	Limit
30 MHz to 1.0 GHz	-107 dBm/Hz
1.0 GHz to 12.75 GHz	-97 dBm/Hz

TEST PROCEDURE

EN 300 328 Clause 5.7.6

TEST PROTOCOL

EN 300 328 Clause 5.7.6

The level of spurious emissions are measured as

their power in a specified load (conducted spurious emissions); and their effective radiated power when radiated by cabinet and antenna.

RESULTS

No non-compliance noted:

RADIATED SPURIOUS EMISSIONS ABOVE 1 GHz

08/27/04 **High Frequency Substitution Measurement**
 Compliance Certification Services, Morgan Hill 5m Chamber Site

Test Engr: NEELESH RAJ
Project #: 04U2926-6
Company: AIRGO
EUT Descrip.: 802.11B/G 2.4GHz BELIKAN GATEWAY (COMPLETE SYSTEM)
EUT M/N: TBD
Test Target: ETSI328
Mode Oper: RX

Test Equipment:

EMCO Horn 1-18GHz Horn > 18GHz Limit High Pass Filter
 T73; S/N: 6717 @3m ETSI 300 328 Rx

RHODE AND SCHWARZ RECEIVER
 Hi Frequency Cables
 (2 ft) (2 ~ 3 ft) (4 ~ 6 ft) (12 ft)

Pre-amplifier 1-26GHz Pre-amplifier 26-40GHz
 T86 Miteq 924341

f GHz	SA reading (dBuV/m)	Ant. Pol. (H/V)	SG reading (dBm)	CL (dB)	Gain (dBi)	Gain (dBd)	ERP (dBm)	Limit (dBm)	Margin (dB)	Notes
NO RECEIVER SPURIOUS EMISSIONS DETECTED ABOVE THE SYSTEM NOISE FLOOR FROM THE RECEIVER										

8. SETUP PHOTOS

RF CONDUCTED MEASUREMENT AT ANTENNA PORT

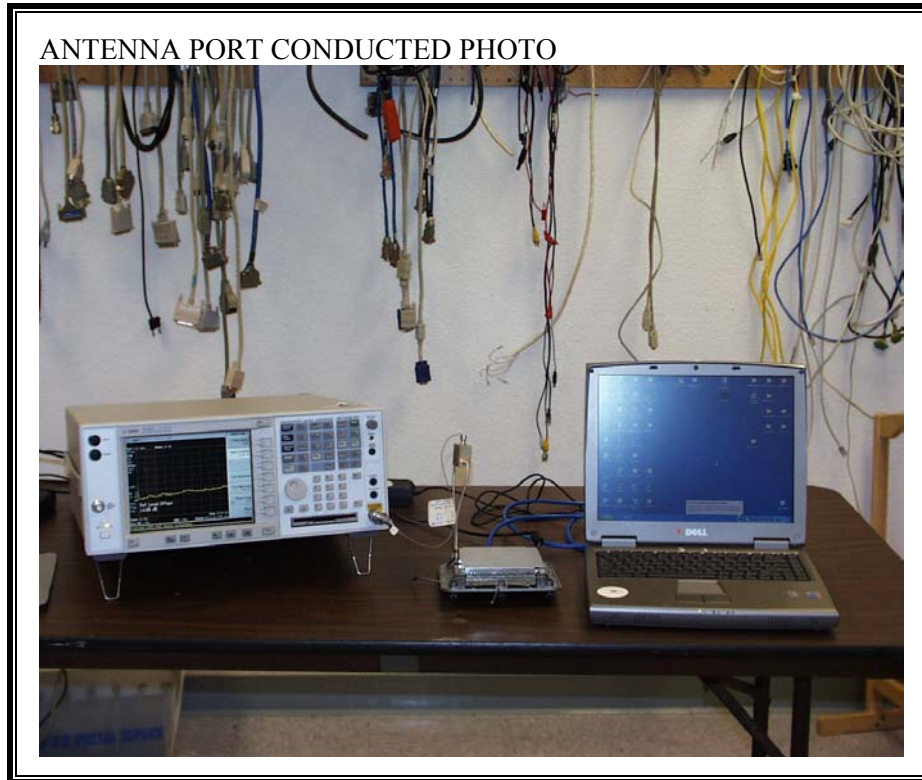

RF CONDUCTED MEASUREMENT OVER NORMAL AND EXTREME CONDITIONS



RADIATED SPURIOUS EMISSIONS

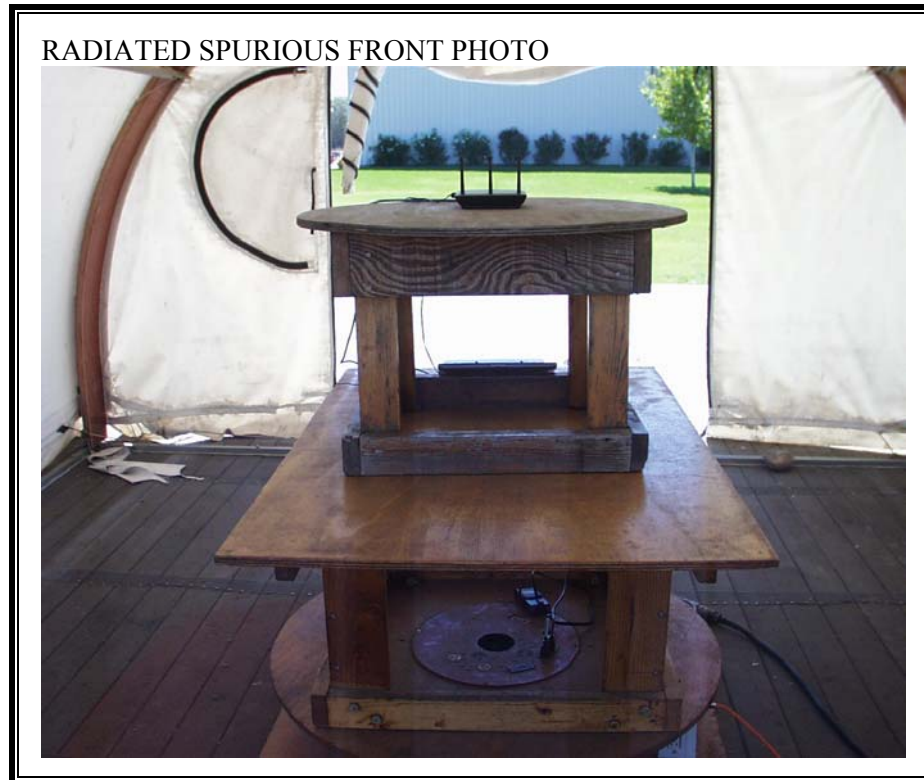



END OF REPORT